

Aurubis AG

Metals for Progress

Roadshow Paris
BNP Paribas Exane

July 5th, 2023

 **Aurubis**



Executive summary of first 6 months 2022/23

| | | |
|---|---|--|
| <p>Operating EBT 6M 2022/23 of € 291 million (PY: € 331 million)¹</p> | <p>ROCE 15.6 % (PY: 19.6 %)¹</p> | <p>Aurubis' positive development continues with the second quarter at the very high level of the previous year</p> <p>Good concentrate markets and product demand led to good Q2 2022/23 figures, despite lower sulfuric acid revenues and higher costs, with well managed energy costs</p> <p>Lower metal result related to input materials; remains a significant contribution to Group's earnings</p> |
| <p>Net cash flow € 19 million (PY: € 54 million)¹</p> | <p>Increased forecast range for FY 2022/23 € 450–550 million op. EBT</p> | <p>Ongoing strong operating performance at our smelter in Pirdop; Hamburg performance stabilized in Q2</p> <p>Net cash flow low due to temporarily high working capital</p> <p>Upward adjustment: op. EBT for FY 2022/23 at € 450–550 million</p> |







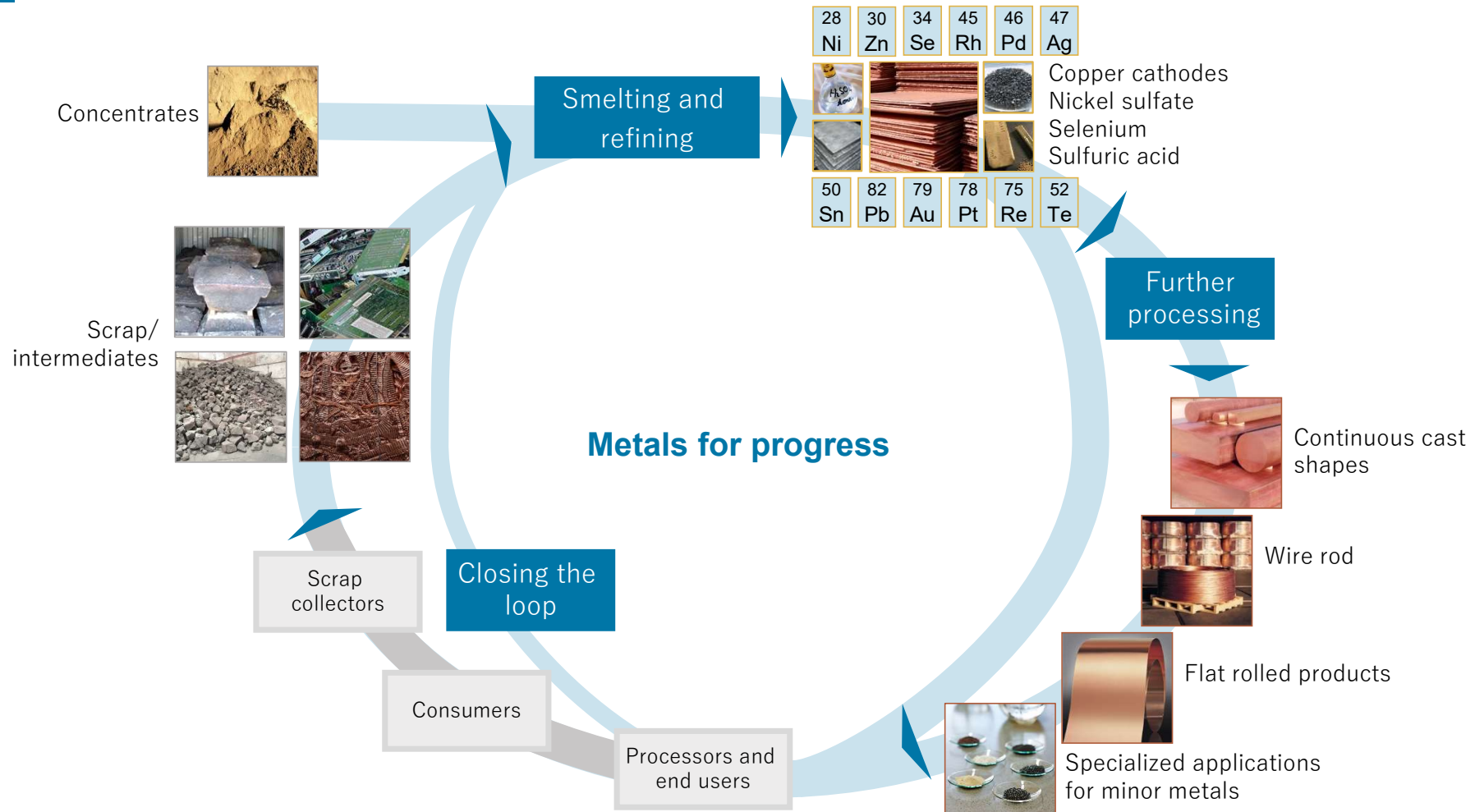

¹ Prior-year figures adjusted

» Good operating performance in Q2 and ongoing strong metal demand led to an increase in the forecast



Closing the loop is part of Aurubis' integrated business model



Increased concentrate throughput and strong product demand

| | FY 2021/22 | Change vs. prior year |
|---|-------------|-----------------------|
|  Concentrate processing ¹ | 2,429,000 t | +8 % |
|  Copper scrap/ blister copper input ² | 540,000 t | -1 % |
|  Other recycling materials ² | 524,000 t | -3 % |
|  Cathode output | 1,111,000 t | + -0 % |
|  Continuous cast wire rod output | 880,000 t | +1 % |
|  Copper shapes output | 218,000 t | +17 % |
|  Flat rolled products + specialty wire output | 176,000 t | -8 % |
|  Sulfuric acid output | 2,296,000 t | +9 % |

¹ Custom smelter production ² Prior-year figures adjusted

| | FY 2021/22 | Change vs. prior year |
|---|------------|-----------------------|
|  Gold | 47 t | -8 % |
|  Silver | 911 t | -4 % |
|  Lead | 44,016 t | +8 % |
|  Nickel | 3,863 t | -1 % |
|  Tin | 9,340 t | -7 % |
|  Zinc | 13,917 t | -24 % |
|  Minor metals | 867 t | -11 % |
|  Platinum group metals (PGMs) | 9,514 kg | +9 % |

Sulfuric acid stabilizes at lower levels, other market conditions stable

Trend in significant market prices and refining charges

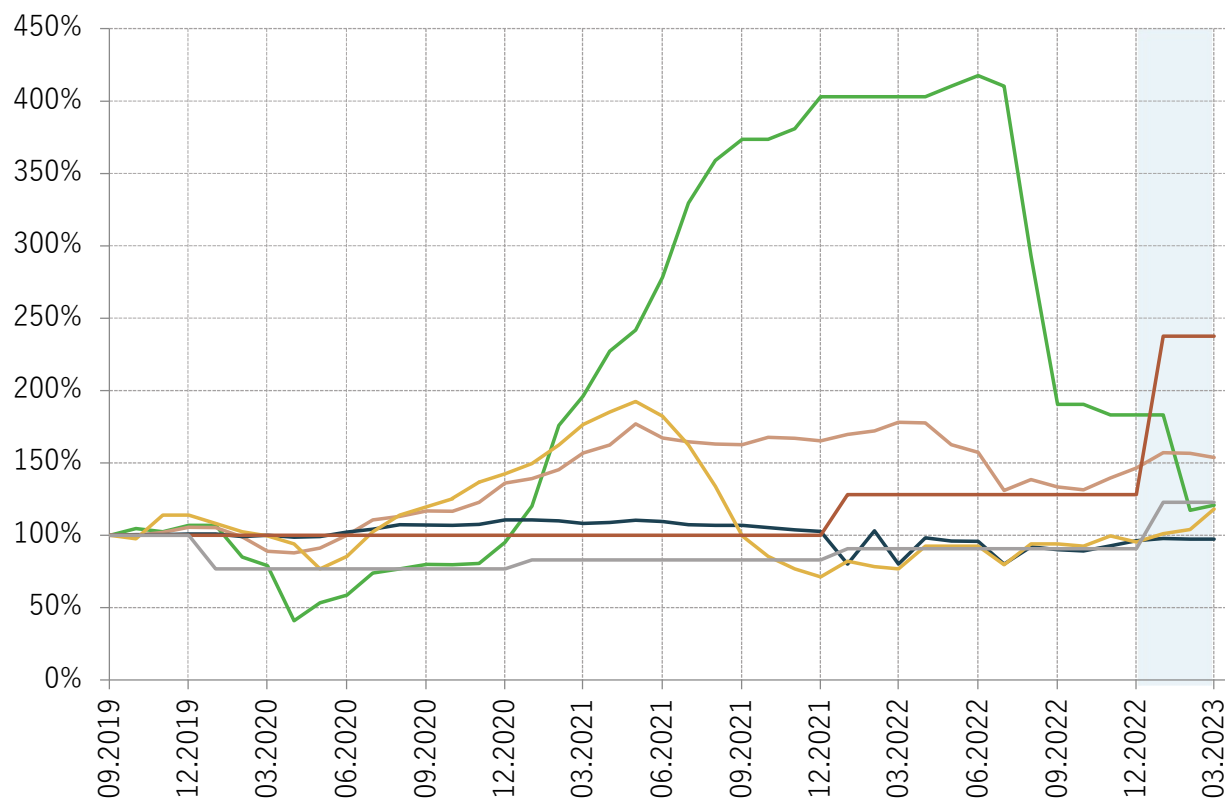

100 % = Sept. 2019

- Sulfuric acid price (spot CFR Brazil)
- Copper price (settlement)
- Exchange rate (US\$/€)
- European refining charges for copper scrap no. 2
- Copper premium
- TC/RCs for copper concentrates (contract)

Aurubis with strong Q2 results and increased forecast

| (operating IFRS) | | 6M 2022/23 | 6M 2021/22 ¹ | Change vs. prior year |
|---|-----|---------------|----------------------------|--------------------------|
| Revenues | €m | 8,784 | 9,262 | -5 % |
| Gross profit | €m | 839 | 857 | -2 % |
| EBITDA | €m | 383 | 426 | -10 % |
| EBIT | €m | 286 | 332 | -14 % |
| EBT | €m | 291 | 331 | -12 % |
| Consolidated net income | €m | 230 | 257 | -11 % |
| Operating ROCE (operating EBIT last 4 quarters) | (%) | 15.6 | 19.6 | - |

¹ Prior-year figures adjusted

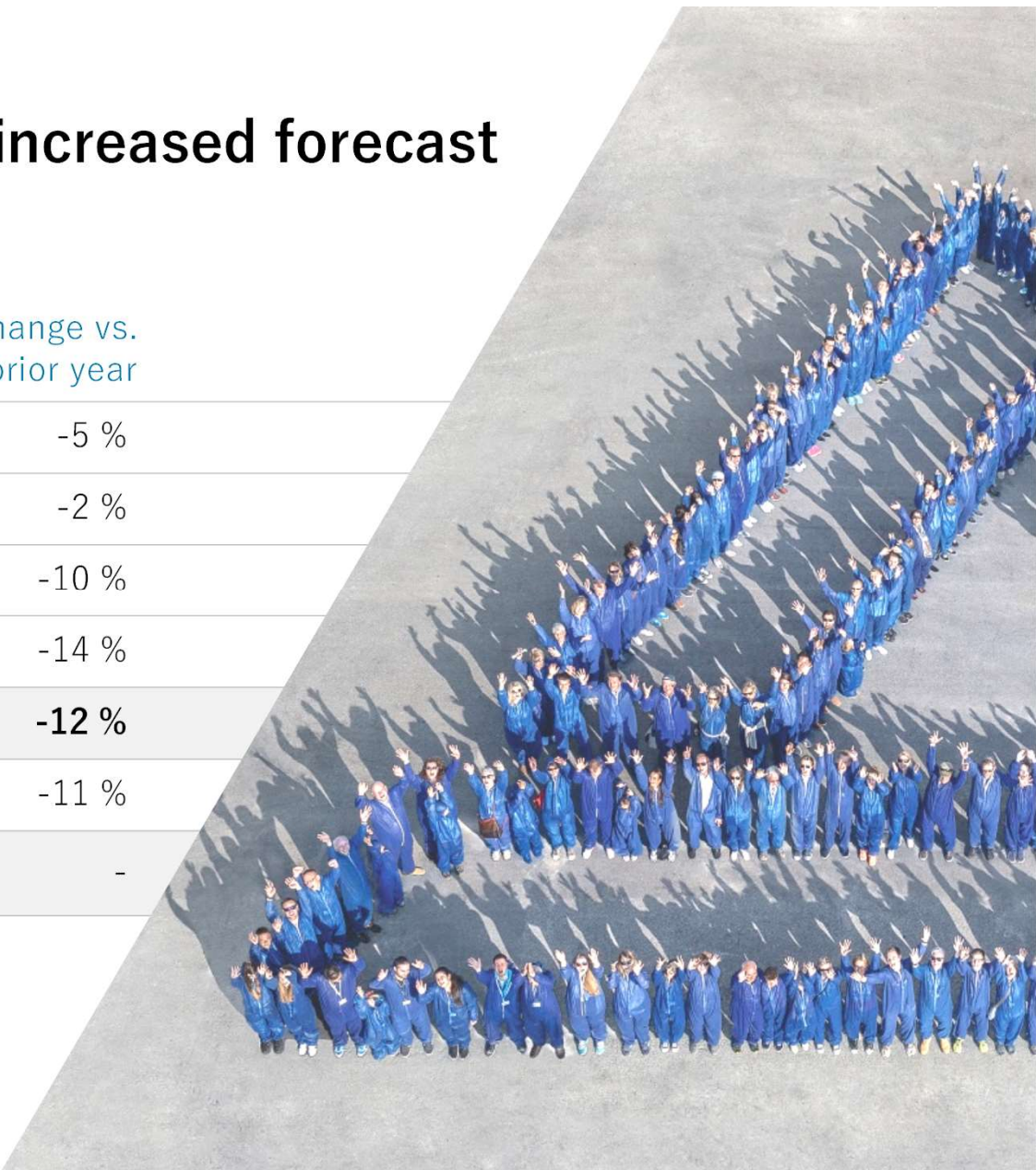

Gross margin at prior-year level

Breakdown of income components in the Aurubis Group 6M 2022/23 YTD (YTD prior-year figures)

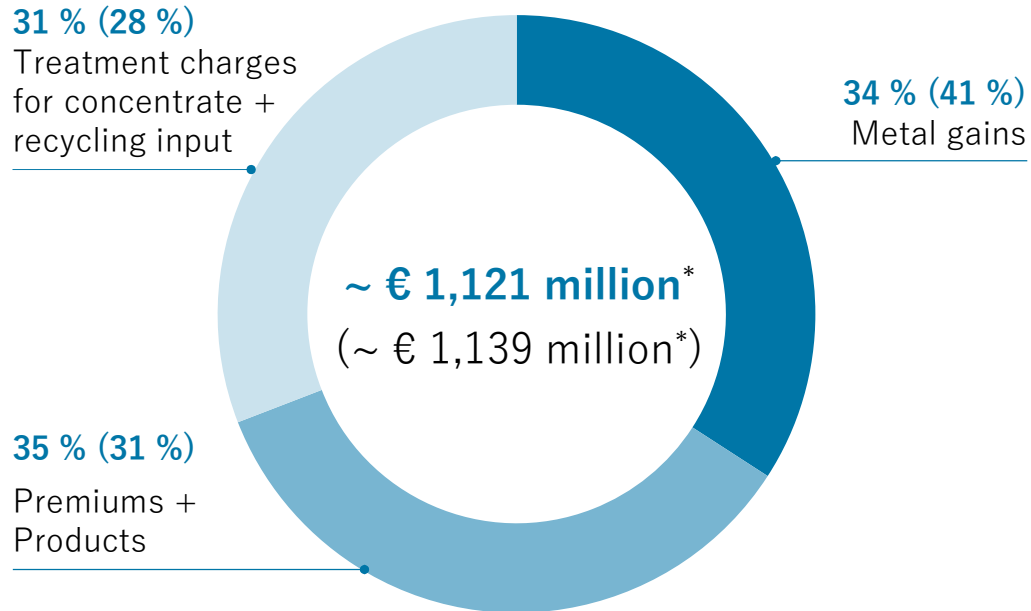

* Gross margin = Total of earnings components metal result, treatment charges for concentrate + recycling input, and premiums + products



Overview of Group costs – energy costs reduced

Overview of cost/expense positions
6M 2022/23 YTD (YTD prior-year figures)

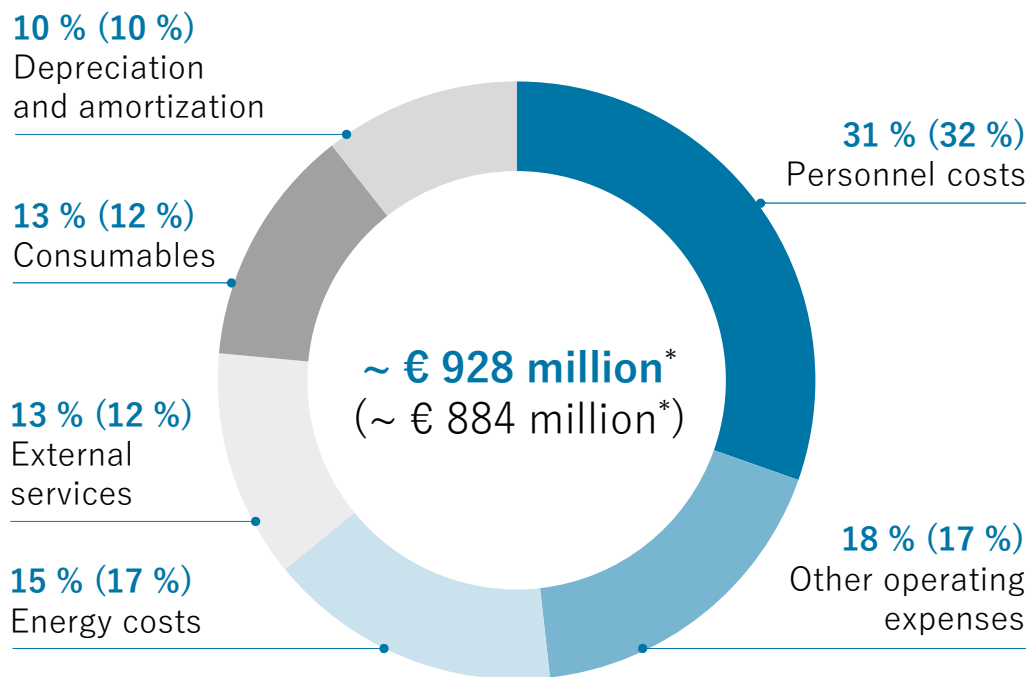

* Figures adjusted by energy compensation and hedging transactions

Aurubis / Roadshow Paris July 5th 2023



Aurubis continues to manage energy costs

Breakdown of energy costs 6M 2022/23
(YTD prior-year figures)

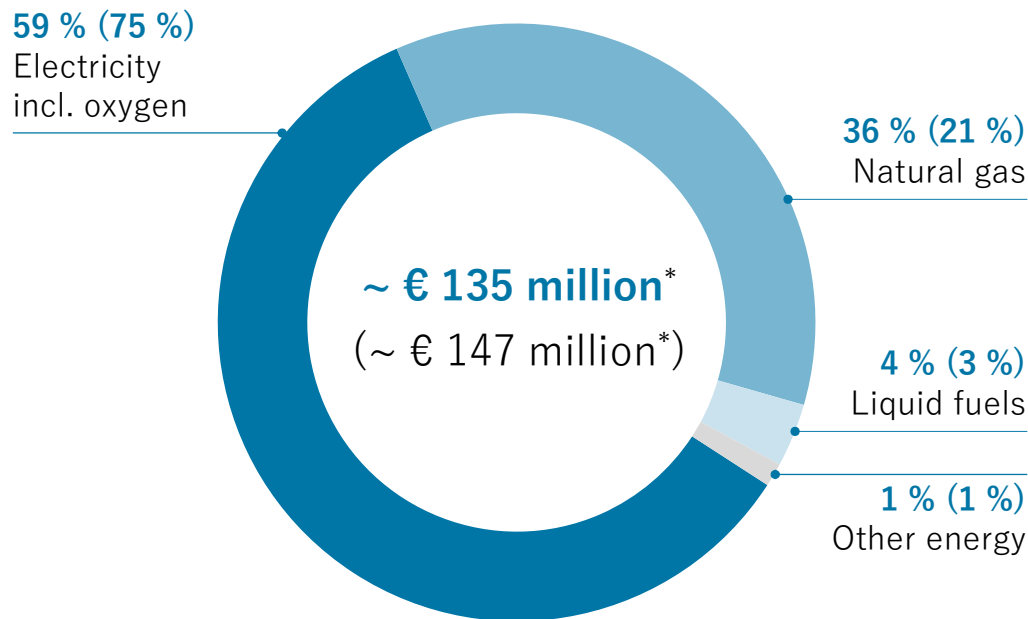

* Figures adjusted by energy compensation and hedging transactions

Electricity incl. oxygen consumption in the Aurubis Group: approx. 1.81 TWh (2022)*

CO₂ emissions of 1.31 million t (2022)*

- 0.52 million t of direct emissions (Scope 1)
- 0.78 million t of indirect emissions related to purchased electricity; market-based (Scope 2)

Key influencing factors for reduction of energy costs in 6M 2022/23:

- Active energy management/hedging transactions
- Electricity price cap in Bulgaria
- Indirect CO₂ compensation (annual payment)

* Preliminary figures

Aurubis' financial position enables our growth strategy

| | | 6M 2022/23 | 6M 2021/22 ³ | Target |
|--|----|---------------|----------------------------|--------|
| ROCE ¹ | % | 15.6 | 19.6 | 15.0 |
| Equity ratio (equity/total assets) | % | 53.1 | 54.0 | > 40.0 |
| Debt coverage ² | | -0.2 | -0.3 | < 3.0 |
| Additional KPIs | | | | |
| | | 6M 2022/23 | 6M 2021/22 | |
| Capital expenditure | €m | 179 | 120 | |
| Capital employed (balance sheet date) | €m | 3,253 | 2,881 | |
| Net cash flow | €m | 19 | 54 | |

¹ Rolling EBIT last 4 quarters

² Net financial liabilities/rolling EBITDA last 4 quarters

³ Prior-year figures adjusted

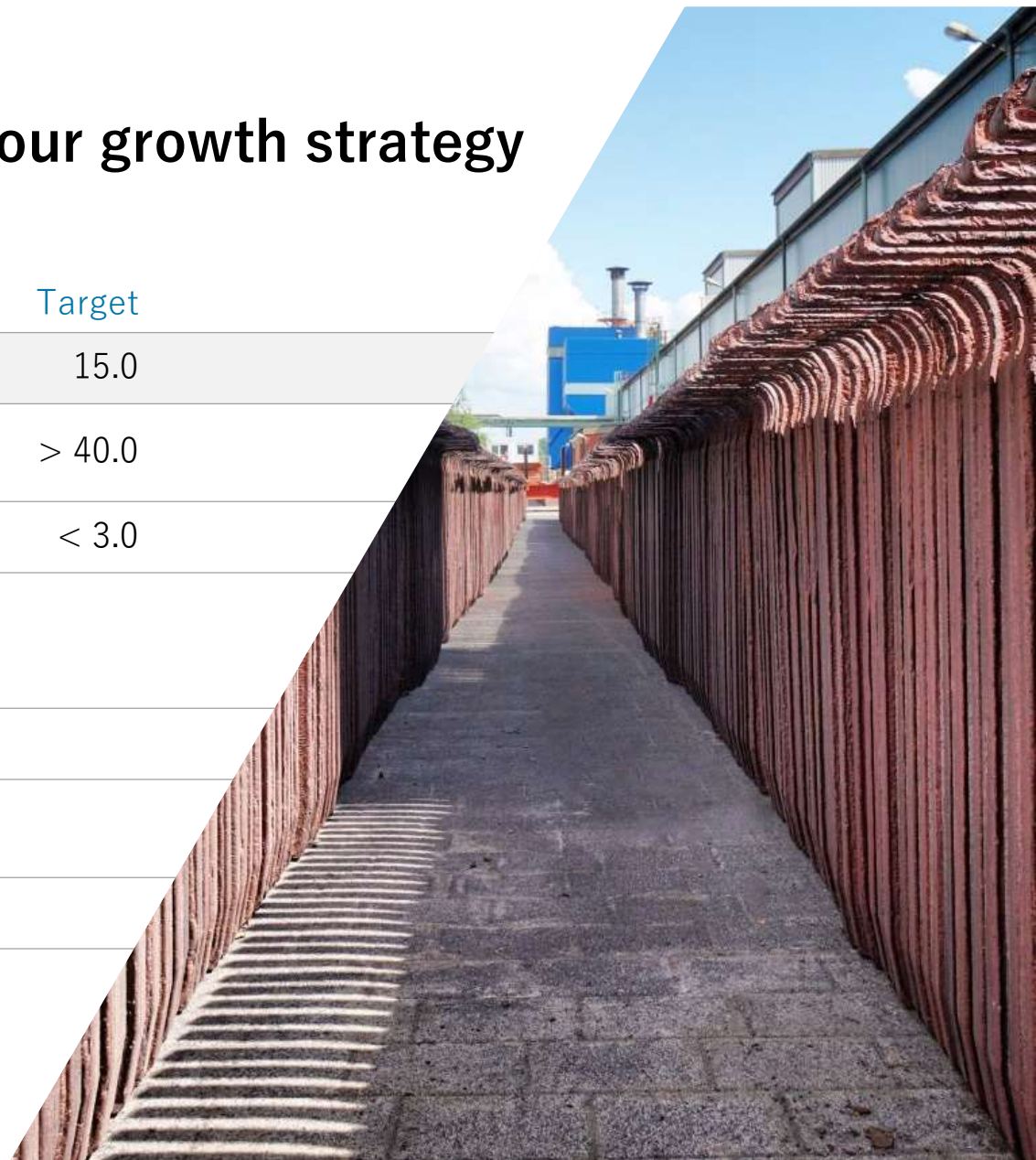

Multimetal Recycling segment

| | | 6M | 6M |
|-----------------------------|-----------|-------------|----------------------|
| Operating results | | 2022/23 | 2021/22 ² |
| EBIT | €m | 102 | 158 |
| EBT | €m | 103 | 158 |
| ROCE¹ | % | 15.5 | 44.4 |
| Quantities | | | |
| Copper scrap/blister copper | mt | 173 | 156 |
| Other recycling materials | mt | 268 | 251 |
| Cathodes | mt | 263 | 258 |

¹ Rolling EBIT last 4 quarters

² Prior-year figures adjusted

Breakdown of income components in MMR segment
6M 2022/23 YTD (YTD prior-year figures)

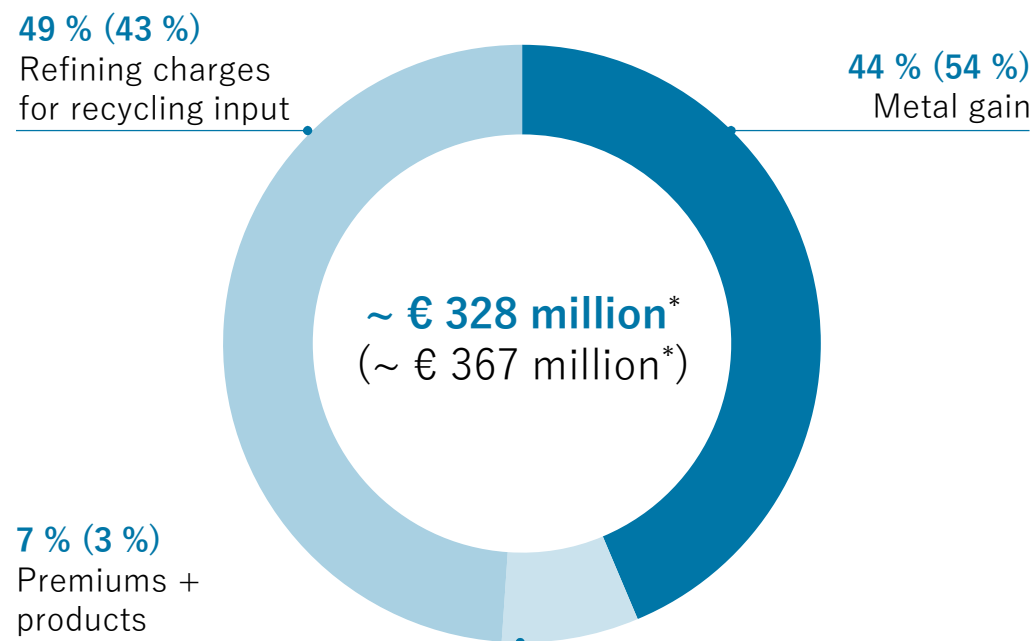

* Gross margin = Total of earnings components metal gain, treatment charges for concentrate + recycling input, and premiums + products

Custom Smelting & Products segment

| | | 6M 2022/23 | 6M 2021/22 ² |
|---|-----------|---------------|----------------------------|
| Operating results | | | |
| EBIT | €m | 220 | 205 |
| EBT | €m | 223 | 205 |
| ROCE¹ | % | 19.1 | 13.7 |
| Quantities | | | |
| Concentrates | mt | 1,262 | 1,314 |
| Copper scrap/blister copper | mt | 101 | 116 |
| Sulfuric acid | mt | 1,183 | 1,238 |
| Cathodes | mt | 305 | 301 |
| Rod | mt | 445 | 435 |
| Shapes | mt | 95 | 111 |
| Flat rolled products and specialty wire | mt | 67 | 88 |

¹ Rolling EBIT last 4 quarters

² Prior-year figures adjusted

Aurubis / Roadshow Paris July 5th 2023

Breakdown of income components in CSP segment
6M 2022/23 YTD (YTD prior-year figures)

24 % (21 %)

Treatment charges
for concentrate +
recycling input

30 % (35 %)
Metal gain

46 % (44 %)

Premiums +
products

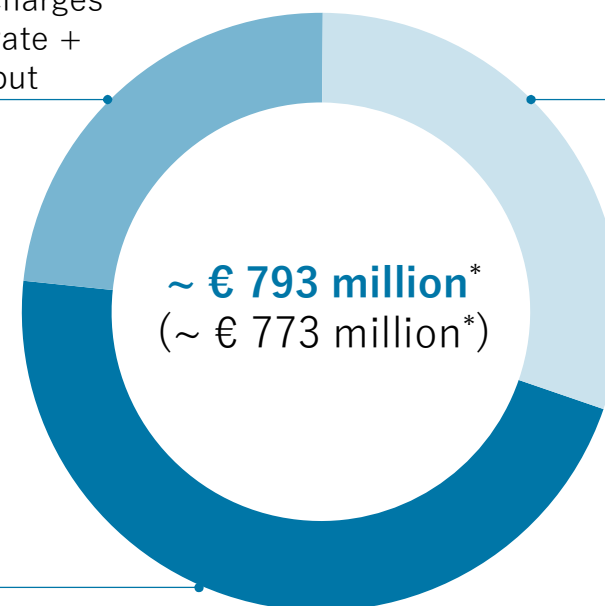

* Gross margin = Total of earnings components metal gain, treatment charges for concentrate + recycling input, and premiums + products

Promising market outlook for 2022/23

Copper concentrates

We anticipate an increase in concentrate supply from the mine side, underpinned by new greenfield projects and the expansion of existing mines. Our smelters are already well supplied into Q4 of FY 2022/23.

Recycling input materials

We expect a stable supply of copper scrap and complex recycling materials for FY 2022/23. The smelter network is already supplied with a considerable amount of recycling materials up until Q4 of FY 2022/23.

Sulfuric acid

Current outlook for FY 2022/23 shows reduced demand from the chemical and fertilizer industries. Both European and overseas markets show lower price levels. We anticipate lower income from sulfuric acid in FY 2022/23.

Aurubis copper premium

Has been set at US\$ 228/t for 2023 (2022: US\$ 123/t).

Other copper products

Outlook for FY 2022/23 shows a mixed picture; we foresee continued strong demand for wire rod, while demand for shapes and flat rolled products is expected to be reduced.

FY 2022/23 guidance

Our forecast range

Operating **EBT**
between € **450** million
and € **550** million

Operating **ROCE**
between **14** %
and **18** %

| | Operating EBT in € million | Operating ROCE in % |
|----------------------------|-------------------------------|------------------------|
| Group | 450–550 | 14–18 |
| Multimetal Recycling | 110–170 | 13–17 |
| Custom Smelting & Products | 390–450 | 18–22 |



Business model resilience based on independence of income components, drives gross margin growth

Breakdown of income components in the Aurubis Group

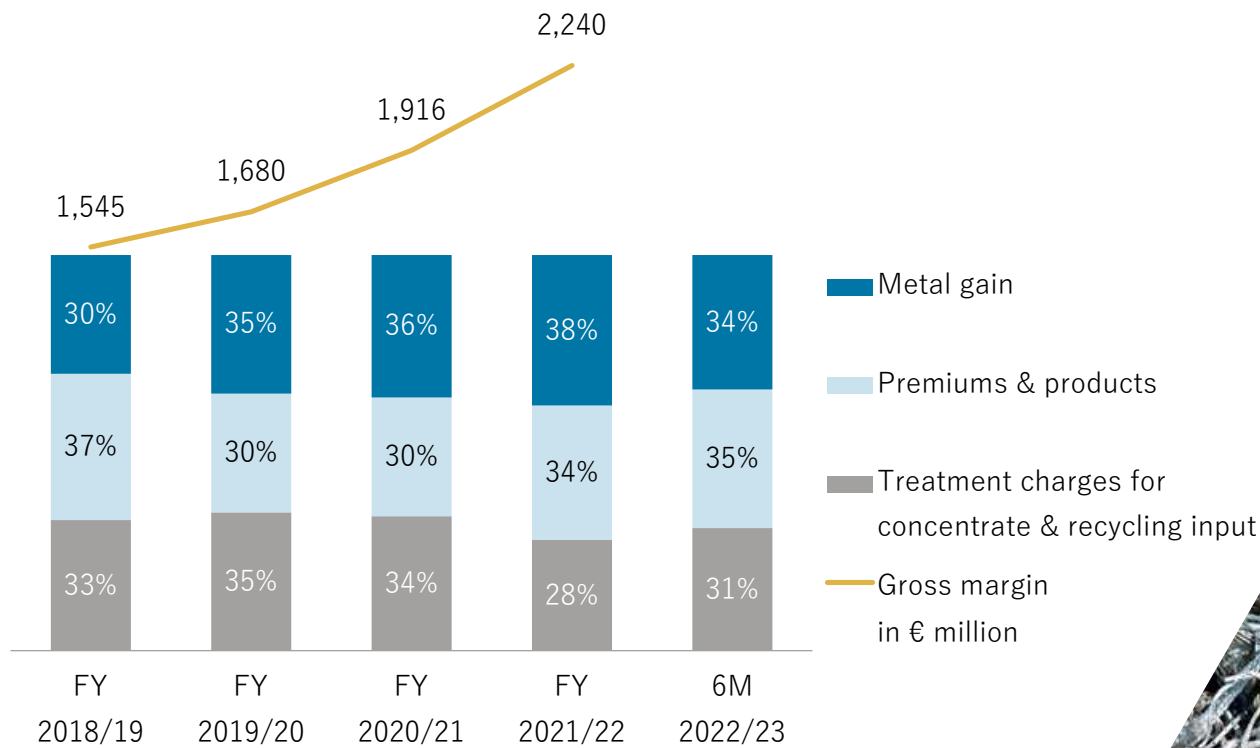

* Gross margin = Total of earnings components metal gain, treatment charges for concentrate & recycling input, and premiums & products



Accumulated EBITDA to rapidly overcompensate investments

Growth investments to be translated into profits

- Investing around € 1.1 billion in strategic growth options
- Rapid payback: accumulated EBITDA of € 1.3 billion overcompensates investments as soon as 2030
- Projects will be financed largely from own resources; current debt coverage offers additional headroom
- Balance sheet to become highly supportive for our EBITDA growth ambitions

Capex & EBITDA contribution from 8 strategic projects (in € million)

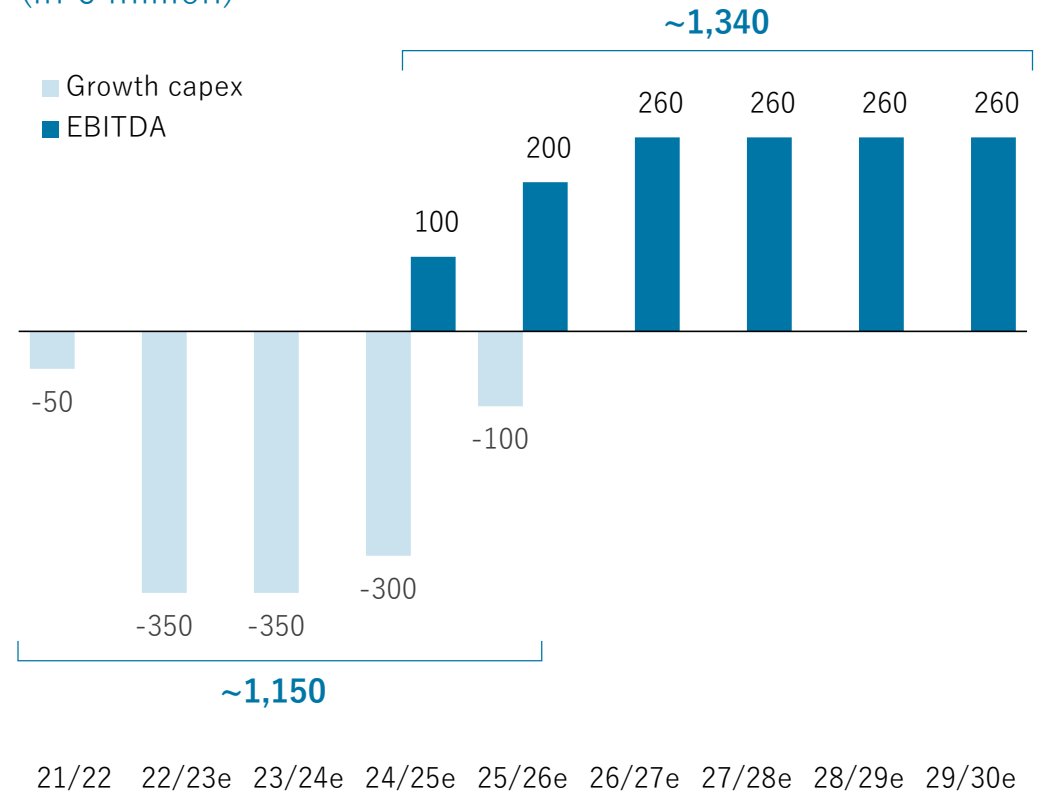

Outflows from current project pipeline expected to peak in 2023/24

Capex planning broken down into baseline and strategic (in € million)

■ Baseline capex ■ Strategic capex ■ Depreciation

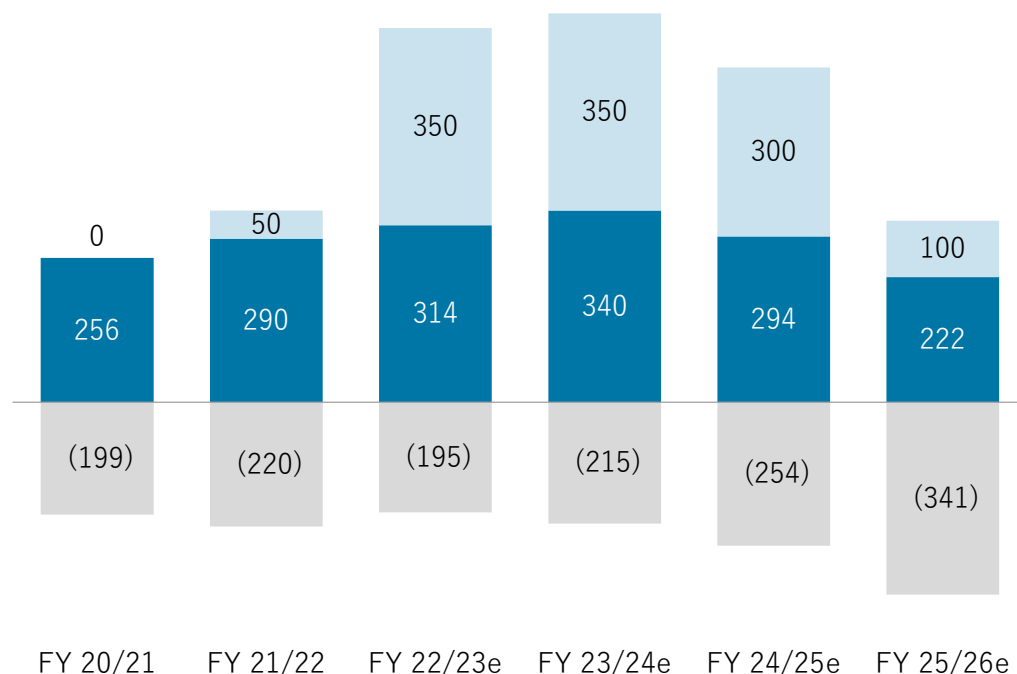

Investment horizon of the Group

- The planned maintenance schedule of the two primary smelters in Hamburg and Pirdop will change from planned maintenance every two years to a three-year cycle from FY 2025/26 onwards
- Depreciation will start substantially impacting the P&L after FY 2025/26, but all projects are accretive to P&L
- Total fixed assets expected to reach around € 3.5 billion by 2025/26

Increased gross margin supported by balanced portfolio

Breakdown of income components in the Aurubis Group

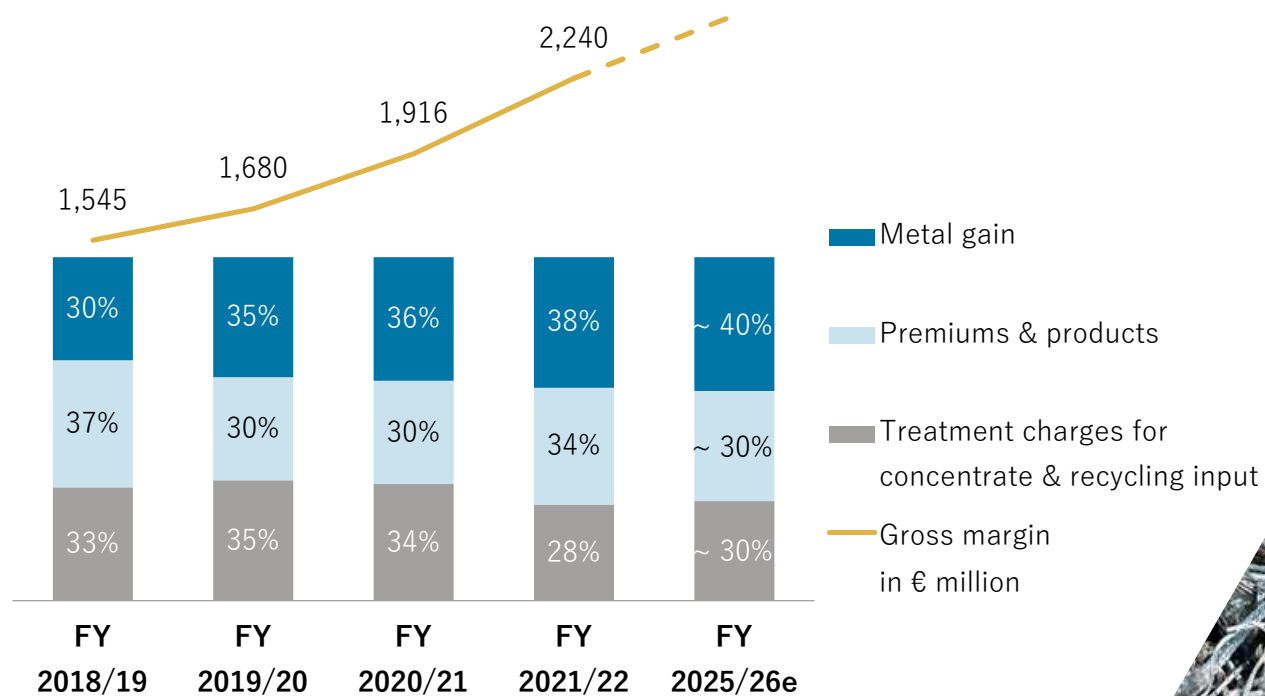

* Gross margin = Total of earnings components metal gain, treatment charges for concentrate & recycling input, and premiums & products

Aurubis / Roadshow Paris July 5th 2023

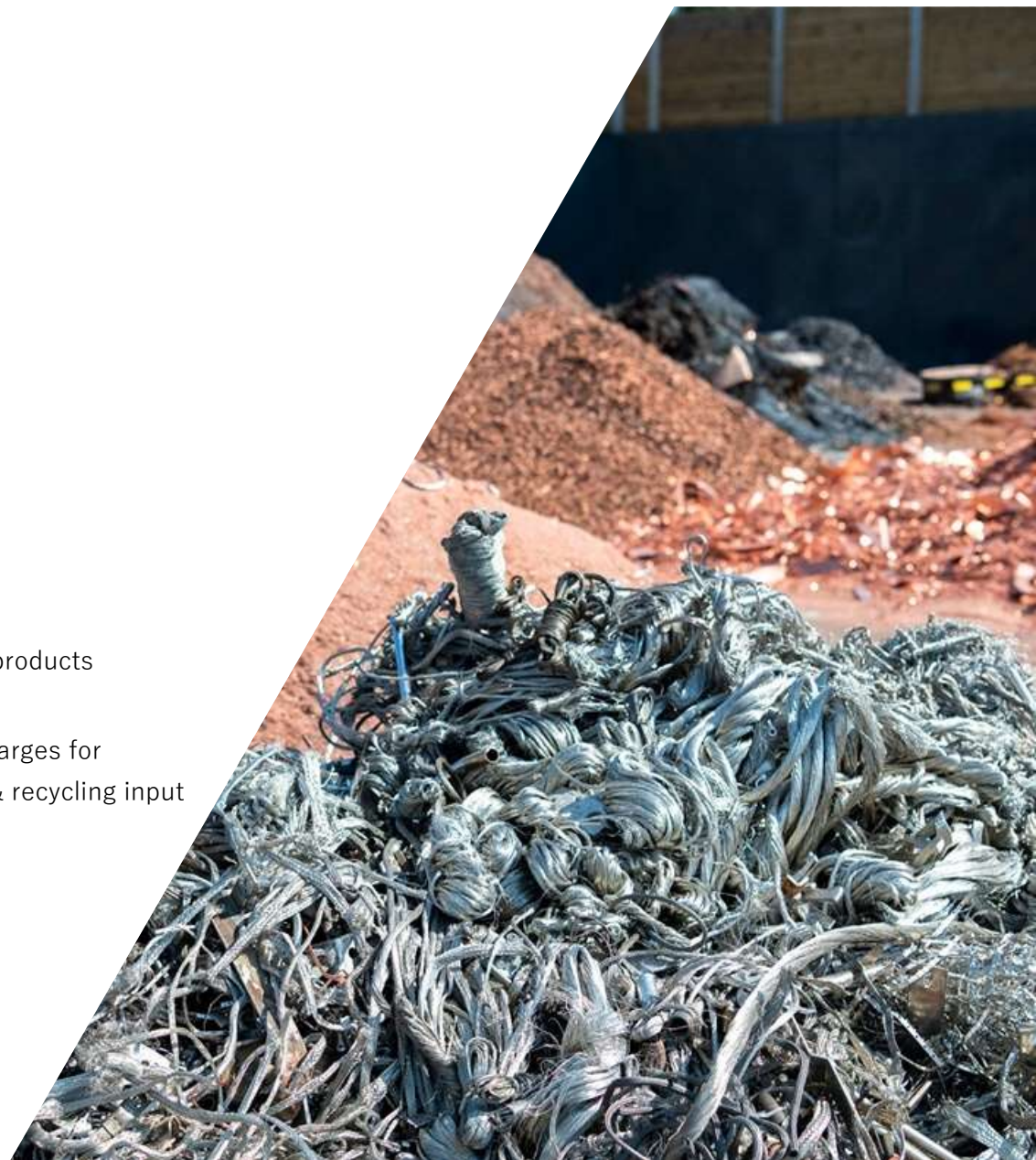

Capital allocation will focus substantially on strategic growth investments

Net cash flow
(in € million)

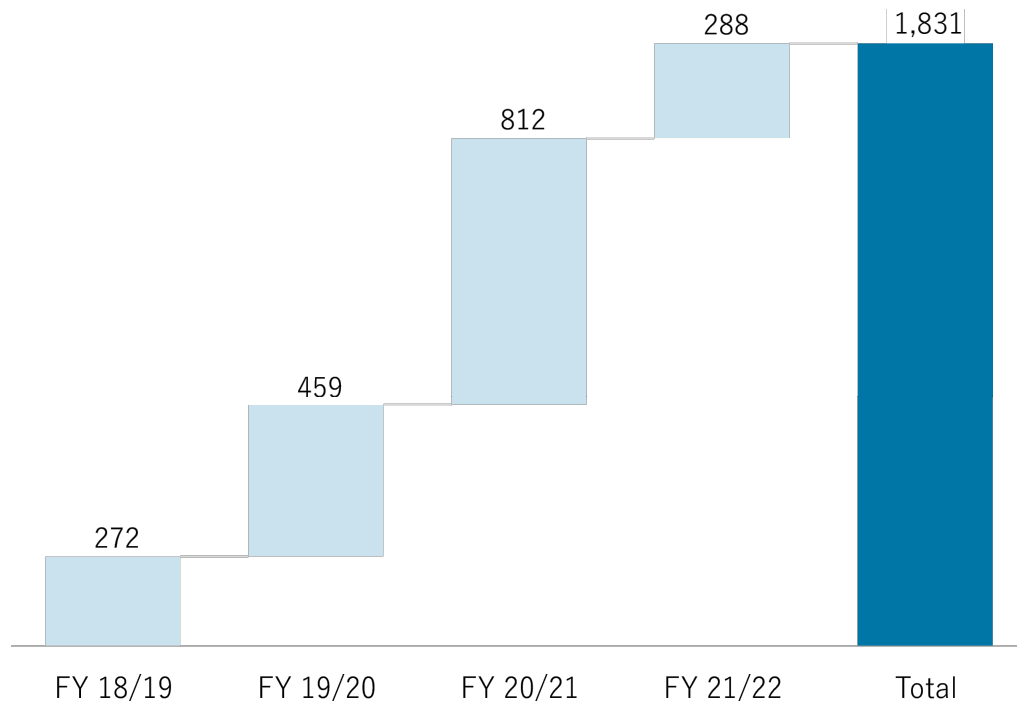

Capital allocation

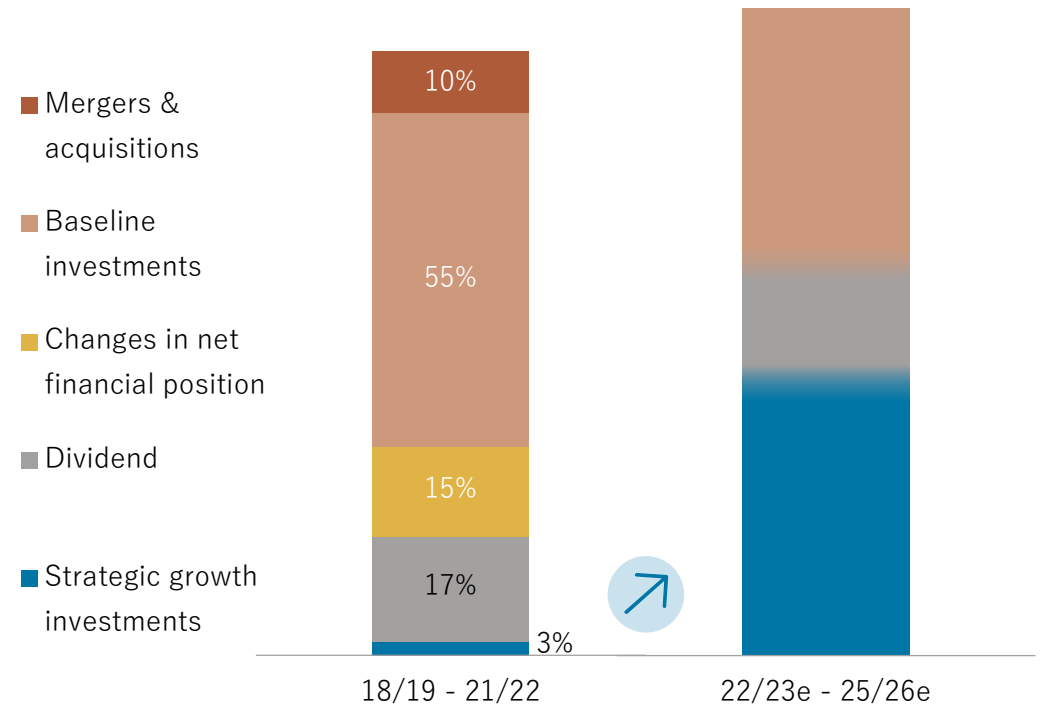

Our strategy builds on the sound mission of Aurubis and covers all relevant aspects to drive sustainable growth



Industry Leadership in Sustainability

- Enablers**
- Digitalization, automation, and “Plant of the Future”
 - Strategic resource management, talent and personnel development



» We are consistently implementing the strategy

Growth strategy: CAPEX and EBITDA impact increase significantly

Short term

Currently approved

- **Growth Capex ~€ 1,100 million approved**
- **Key projects** Aurubis Richmond Module 1 & 2, Tankhouse Pirdop, CRH, BOB, ASPA, Industrial-heat II, PV 2&3 Pirdop
- **EBITDA of ~€ 260 million** starting 2026/27, thereof **~€ 170 million** from Aurubis Richmond

Medium term

Medium-term planning (next 4 years)

- **Growth Capex ~€ 280 million** are included in the medium-term planning
- **EBITDA ~€ 70 million** in addition from planned strategic projects
- Additional strategic projects, e.g., **the modular recycling system (€ 250–300 million Capex) / battery recycling**, not yet included, but are actively pursued

Long term

Until 2030

- **Ambition and scale of our long-term growth and project plans** remain at a high level
- All Capex projects are subject to a **sustainability assessment** (especially CO₂- contribution)
- **Battery recycling remains a priority growth area**

Timeline of strategic projects in implemetation

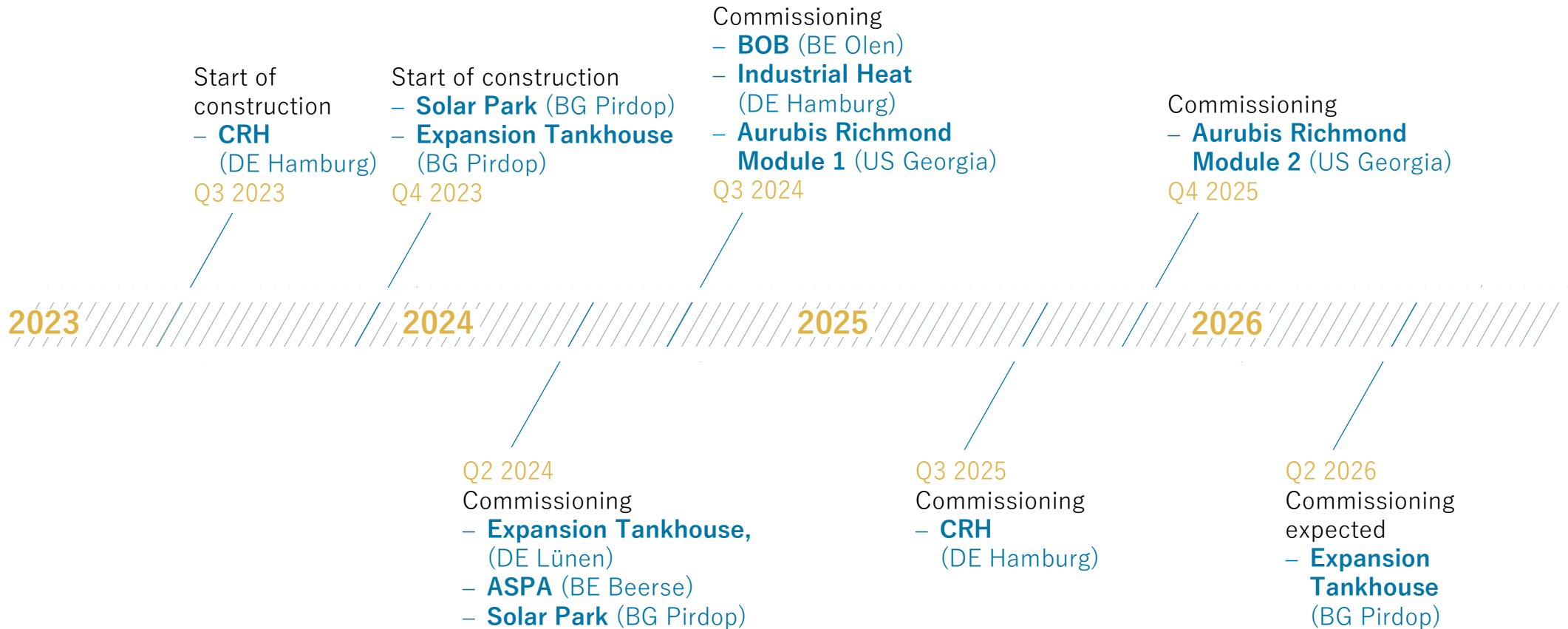

Expanding our flowsheet with additional smelting furnaces and processes to drive multimetal growth strategy

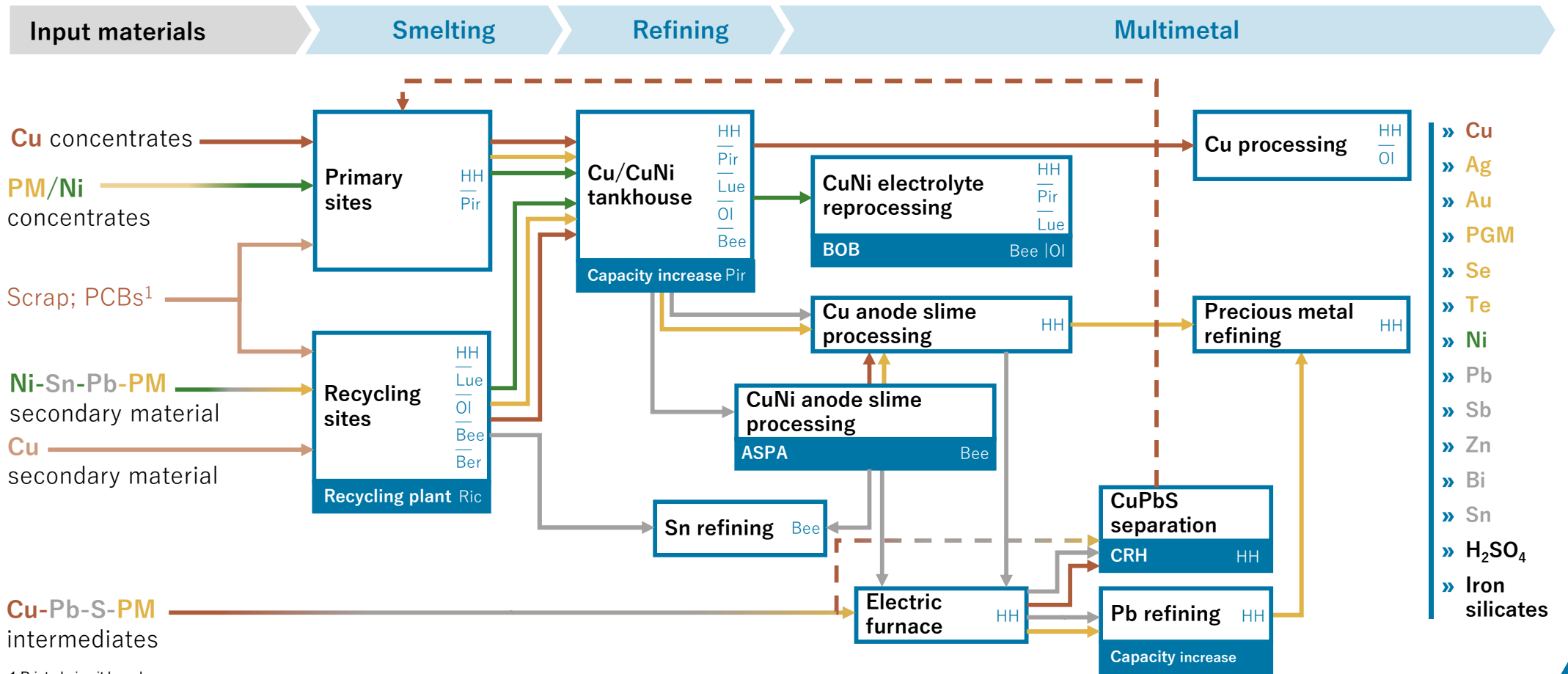

¹ Printed circuit boards

Growth options

Aurubis Richmond, US – construction work is progressing



Very attractive market environment: Relevant recycling materials to grow at ~5 % p.a. in North America

Pursuing growth in North America

US-relevant recycling market (kt p.a.)

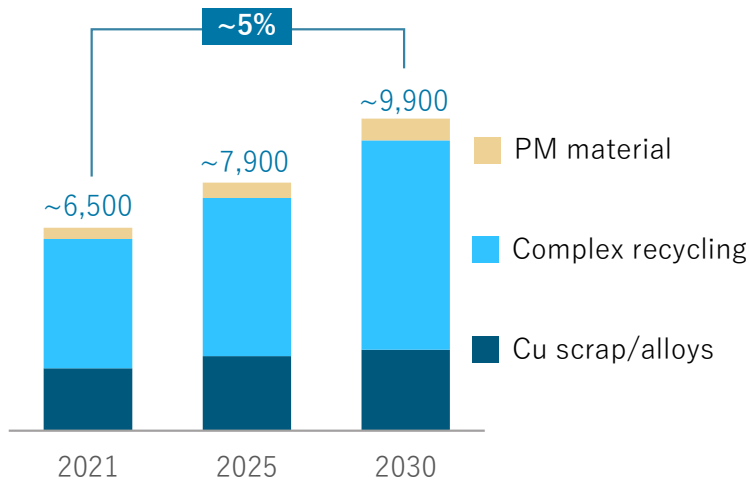

Printed circuit boards (PCB) supply (kt p.a.)

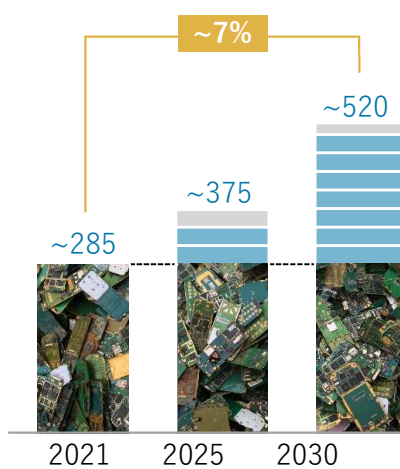

Metal shredder supply (kt p.a.)

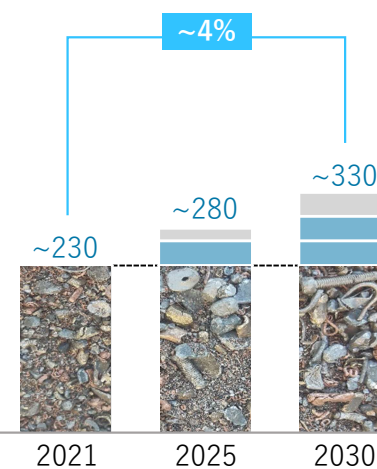

Insulated copper wire supply (kt p.a.)

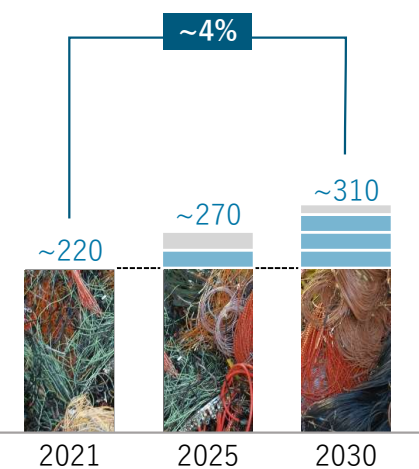

Key growth drivers



Collection rates
Increasing collection rates, especially of bulk e-waste and PCB materials (currently only ~30 %)



Declining exports
Net export of copper scrap continuously decreasing due to increasingly restrictive import policies in China/SEA



Incremental growth
Continuous growth of industrial activity and consumption of electronics lead to solid growth base

Aurubis Richmond – the leading processor of electric and electronic recycling materials in the US



| | | |
|---|---|--|
| <p>Investment</p> <p>~ € 640 million</p> | <p>EBITDA p.a.</p> <p>~ € 80 million (by 2025/26)</p> <p>~ € 170 million (by 2026/27)</p> | <p> Pursue Growth Options</p> <p>Aurubis Richmond complements and expands our international integrated smelter network with a highly attractive investment in a promising growth market.</p> <p>The total investment includes additional infrastructure investments and inflation.</p> <p>Aurubis Richmond establishes us as the front-runner in the US recycling market – tied directly to our strength, innovative expertise, industry-leading metallurgical processes and flexible applications.</p> <p>With this, Aurubis will become the leading processor of electrical and electronic scrap in the US, by doubling the throughput capacity and output.</p> <p>In total ~200 new jobs.</p> |
| <p>Start of production following ramp-up phase</p> <p>Module 1: 2024</p> <p>Module 2: 2026</p> | <p>~ 180,000 t input material</p> <p>~ 70,000 t blister copper output</p> | |

➤ **Project strengthens the circular economy and underlines Aurubis' ambition to strengthen and expand our position as the most efficient integrated smelter network worldwide**

Aurubis Richmond with significant progress since groundbreaking in June 2022 – first equipment received in May 2023



First equipment

June '22

June '23

November '23

June '24

Start of hot
commissioning
(Module 1)

May '23

Start of sampling/
pre-processing

Start of cold
commissioning
(Module 1)

August '24

Groundbreaking

Status today



Key project statistics:

- **Visible progress:** 24.7 t m² concrete poured, 17.5 t m² PEMB¹ erected
- **Module 1:** € 290 m capex contracted; € 87 m capex spent²
- **Module 2:** OEM & crane manufacturer **contracts signed** – construction and equipment installation contracts to follow shortly
- **Project & Operational teams:** key project roles & senior mgmt. team staffed (~60 FTE in May 2023) – strong hiring to continue until 2024
- **Forecast of € 392 m and project schedule substantiated** – proactive value engineering and pursuit of cost savings opportunities

¹ Pre-engineered metal buildings; ² Status 6M 2022/23

Secure core business: Complex Recycling Hamburg (CRH) – further optimization of smelting process





CRH



Secure & strengthen core business

CRH: Further optimization of the smelting process in Hamburg



| Investment ~ € 190 million | EBITDA p.a. ~ € 40 million <small>(at full production)</small> |  Secure Core Business   Strengthen Core Business |
|---|--|--|
| Start of production following ramp-up phase Q4 2025 | ~ 32,000 t p.a. Input of external material | <p>Aurubis is <u>strengthening its core business</u> and investing € 190 million for further optimization of the smelting process at the Hamburg site.</p> <p>Construction of a new TBRC at the Hamburg site incl. process gas cleaning system based on best available techniques (BAT).</p> <p>Processing <u>internal and external value-added complex intermediates and recycled materials</u> with additional treatment and refining charges and metal recoveries.</p> <p>Increase in metal yield (mainly precious metals) with lower process times.</p> <p>CRH is the prerequisite for further attractive strategic projects (e.g., higher yield of additional industrial and precious metals).</p> <p>Differentiation from competitors through expansion of metallurgical processes and extension of the value chain at the Hamburg site.</p> |

➤ **Project underscores Aurubis' commitment to its Hamburg site, while increasing capacities for the sustainable recovery of metals from intermediates and complex recycling materials**

Secure & strengthen core business Expanding the tankhouse in Pirdop



Anticipated and growing metal supply deficits in North America and Europe drive key growth opportunities for our core business

Refined copper market balance (in Mt)

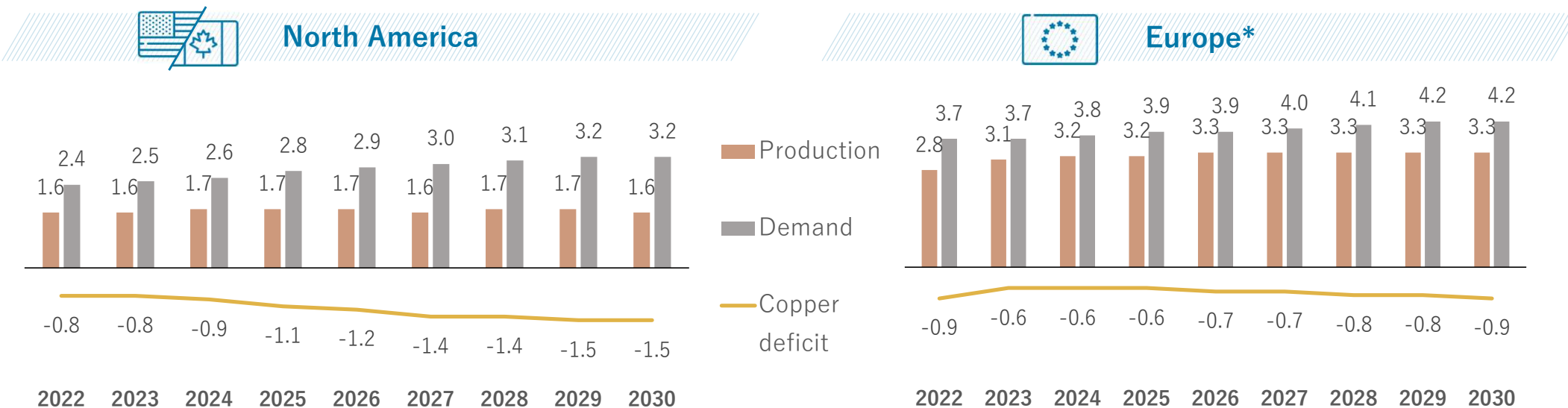

Relevant markets show structural undersupply of refined copper

Greater regionalization of the recycling business will require increased local production to fill anticipated supply gaps in key markets



Market trends confirm our strategy to expand existing and build new regional capacities

* Europe incl. Turkey
Source: Wood Mackenzie Copper Outlook Q1/2023

Secure & strengthen core business

Expanding the tankhouse in Pirdop



| | | | |
|---|---|---|--|
| <p>Investment ~ € 120 million</p> | <p>EBITDA p.a. ~ € 30 million (at full production)</p> | <div style="display: flex; align-items: center; justify-content: space-between;"> <div style="text-align: center;">  <p>Secure Core Business</p> </div> <div style="text-align: center;">  </div> <div style="text-align: center;">  <p>Strengthen Core Business</p> </div> </div> | |
| <p>Start of production following ramp-up phase second half of 2026</p> | <p>~ 120,000 t p.a. additional capacity</p> | <p>Aurubis is <u>strengthening its core business</u> and investing € 120 million in expanding the tankhouse at its Bulgarian site in Pirdop.</p> <p><u>Processing of around 340,000 tons of copper cathodes</u> in the future, which corresponds to an increase of around 50 %.</p> <p><u>Further optimization of material flows</u> in the smelter network.</p> <p><u>Reduction of our logistics costs and the CO₂ footprint</u> associated with them.</p> <p>Expansion also creates the conditions for additional strategic projects at other Aurubis Group sites.</p> | |

» By expanding production capacity, Aurubis is investing in a growing market and making another contribution to driving innovations and technological advances.

Secure & strengthen core business Advanced Sludge Processing by Aurubis (ASPA)





ASPA



Secure & strengthen core business Advanced Sludge Processing by Aurubis (ASPA)



| | | | |
|--|---|---|--|
| <p>Investment ~ € 33 million</p> | <p>EBITDA p.a. ~ € 7 million <small>(at full production)</small></p> | <p> Secure Core Business</p> <p></p> <p> Strengthen Core Business</p> | |
| <p>Start of production following ramp-up phase FY 2024/25</p> | <p>~ 2,500 t p.a. input material in form of anode sludges</p> | <p>Aurubis is strengthening its core business and taking the next step towards becoming the most efficient and sustainable integrated smelter network worldwide.</p> <p>Construction of a state-of-the-art recycling facility at the Beerse site (BE).</p> <p>ASPA, a newly developed hydrometallurgical process, will extract more valuable metals such as Au, Ag, and Sn from anode sludge faster.</p> <p>Prime example of the synergies created by the Metallo acquisition and how the whole company benefits in developing new innovative solutions together.</p> | |

➤ **Project capitalizes on synergies from the Metallo acquisition and contributes significantly to a well-functioning circular economy**

Secure & strengthen core business Bleed treatment Olen Beerse (BOB) – Construction kick-off





BOB



Secure & strengthen core business Bleed treatment Olen Beerse (BOB)



| | | | |
|---|--|--|--|
| <p>Investment ~ € 70 million</p> | <p>EBITDA p.a. ~ 15 million <small>(at full production)</small></p> | <p> Secure Core Business</p> <p></p> <p> Strengthen Core Business</p> | |
| <p>Start of production following ramp-up phase Summer 2024</p> | <p>~ 81,000 t p.a. Input metric tons bleed per year</p> | <p>Aurubis is strengthening its core business and investing € 70 million in the Aurubis site in Olen to increase recycling capacity of the important industry metals nickel and copper.</p> <p>BOB is a state-of-the-art energy-efficient process to extract impurities from bleed (also known as electrolyte) and optimize material streams of nickel and copper.</p> <p>Start of construction is planned for September 2022 with a planned start of the plant in July 2024. The facility does provide spare capacity for future expansion of the asset.</p> <p>Expected full EBITDA impact of about € 15 million, once in full operation in FY 2025/26.</p> | |

➤ **This project is another prime example of how Aurubis realizes synergies in its smelter network and contributes significantly to the European circular economy.**

Lithium-ion batteries – exceptional value hidden in complex products, complex recycling material

Batteries are complex scraps that are of huge value

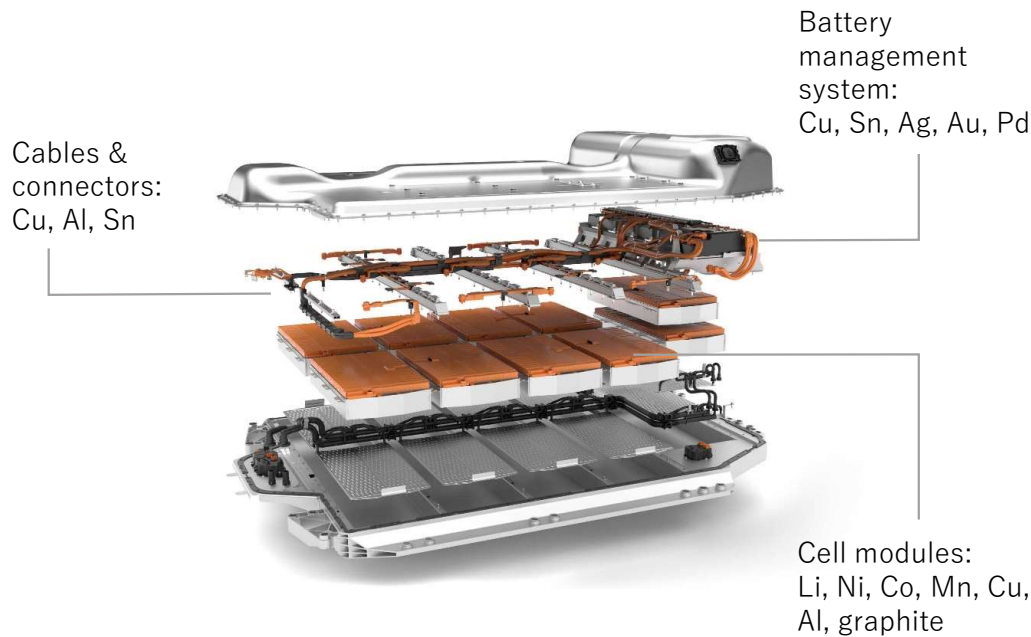

➤ Average black mass content: ~40 %

Source: BMW Group

Aurubis / Roadshow Paris July 5th 2023

As the metal value in black mass is very high, capabilities to recover the value are essential

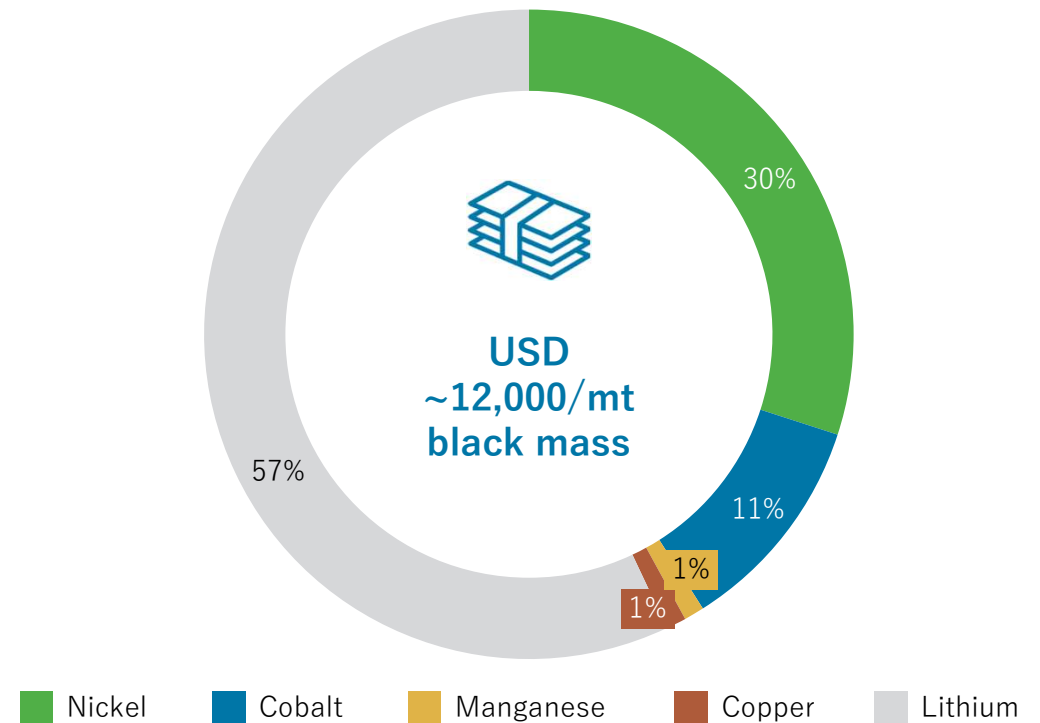

Source: Aurubis, Roland Berger, LME

Our innovative process for black mass leverages capabilities of our integrated smelter network

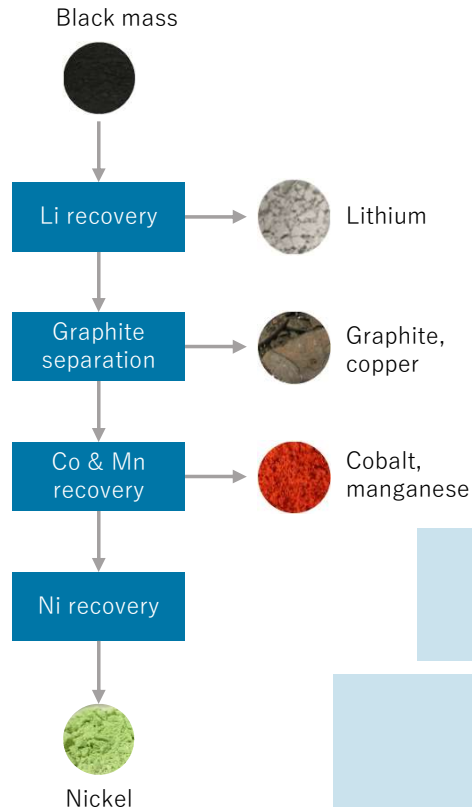

Benefits of the unique Aurubis process

Innovative process route for black mass that utilizes ozone

High lithium recovery through lithium first extraction

Ability to process non-nickel-bearing black mass by focusing on lithium first

Flexibility regarding raw material input – no recycling material is identical to the next

Modularity – compatible with further refining steps

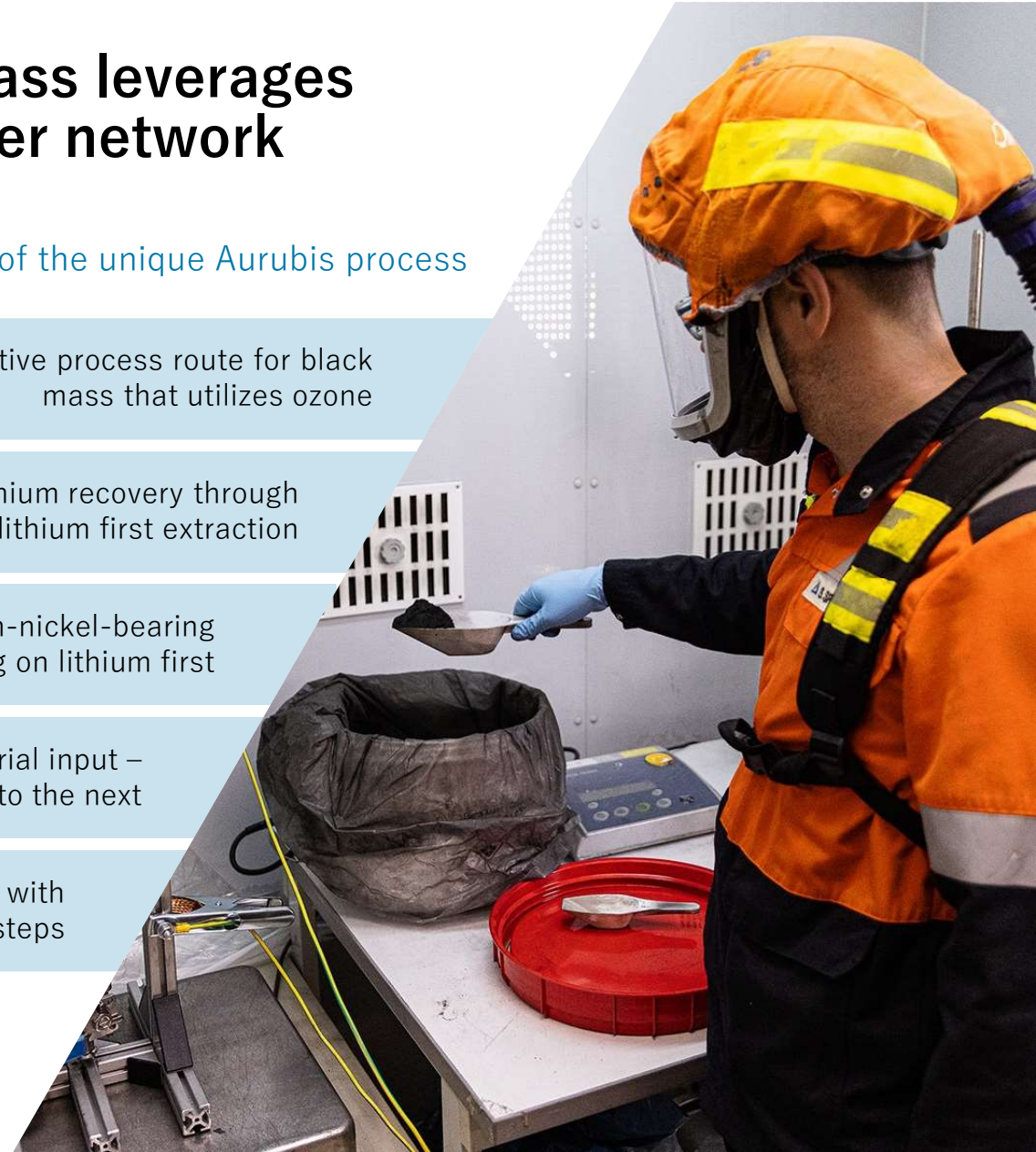

Our sweet spot in the battery recycling value chain is based on Aurubis' core expertise

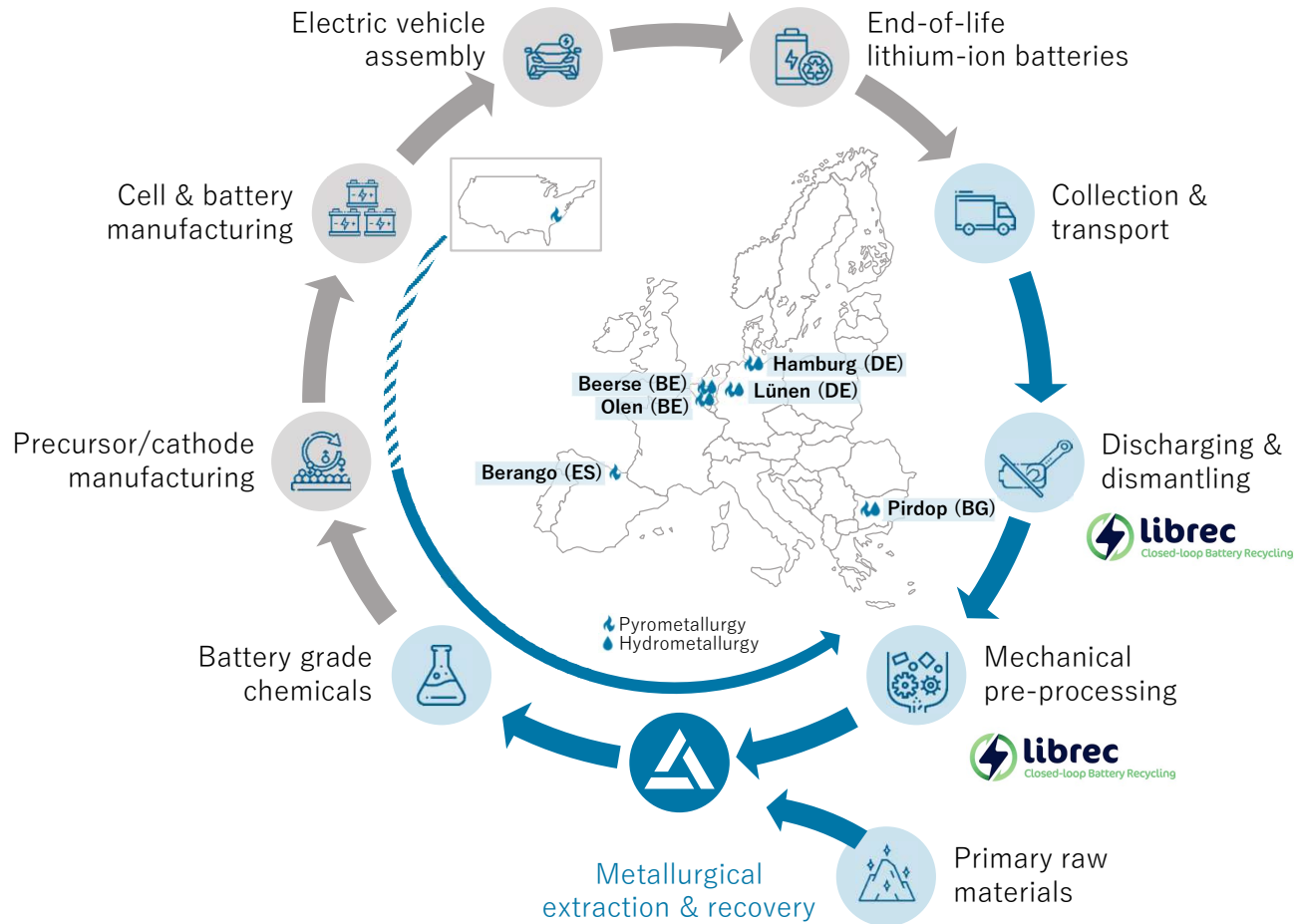

We are developing a fully-fledged battery recycling supply and value chain

First steps taken with Librec, a specialist company in Switzerland, to optimize metallurgy vis-à-vis pretreatment

Further existing partners with core expertise in recycling to cover the production of black mass

Aurubis' integrated smelter network offers unique benefits

Downstream: intensive partnership discussions with experts in chemicals production to close the loop in battery metals

In line with projected market growth, Aurubis could enter the commercial market in the second half of this decade

Regional supply of black mass for recycling (in kt)

■ Europe ■ US & Canada

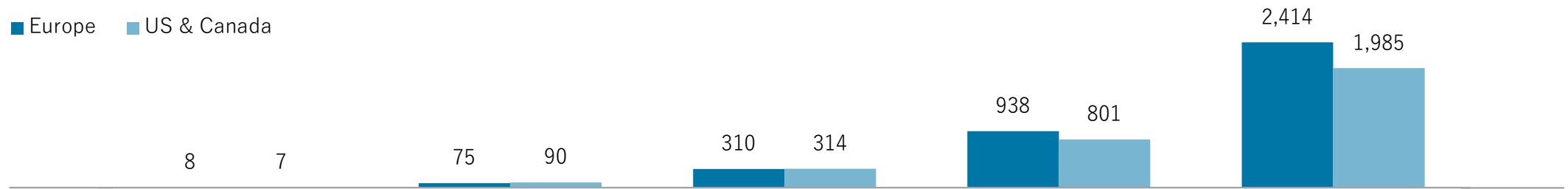

2020

2025

2030

2035

2040

Further pilot test work campaigns (pilot & demo)

Engineering & construction

Commissioning & operation

Feasibility study

First commercial activities with demo plant in 2024

Start of commissioning commercial plant in 2026/27

Criteria for site selection of commercial plant determined; site selection process is underway as we speak

Demo plant will already deliver output on a small commercial scale, enabling build-up of market know-how and reputation

Industrial scale commercialization foreseen for 2026/27

Source: Rhomotion, Q2 2023

Aurubis / Roadshow Paris July 5th 2023

We continue to lead our industry in sustainability – minimizing emissions and costs, maximizing opportunities in new business areas

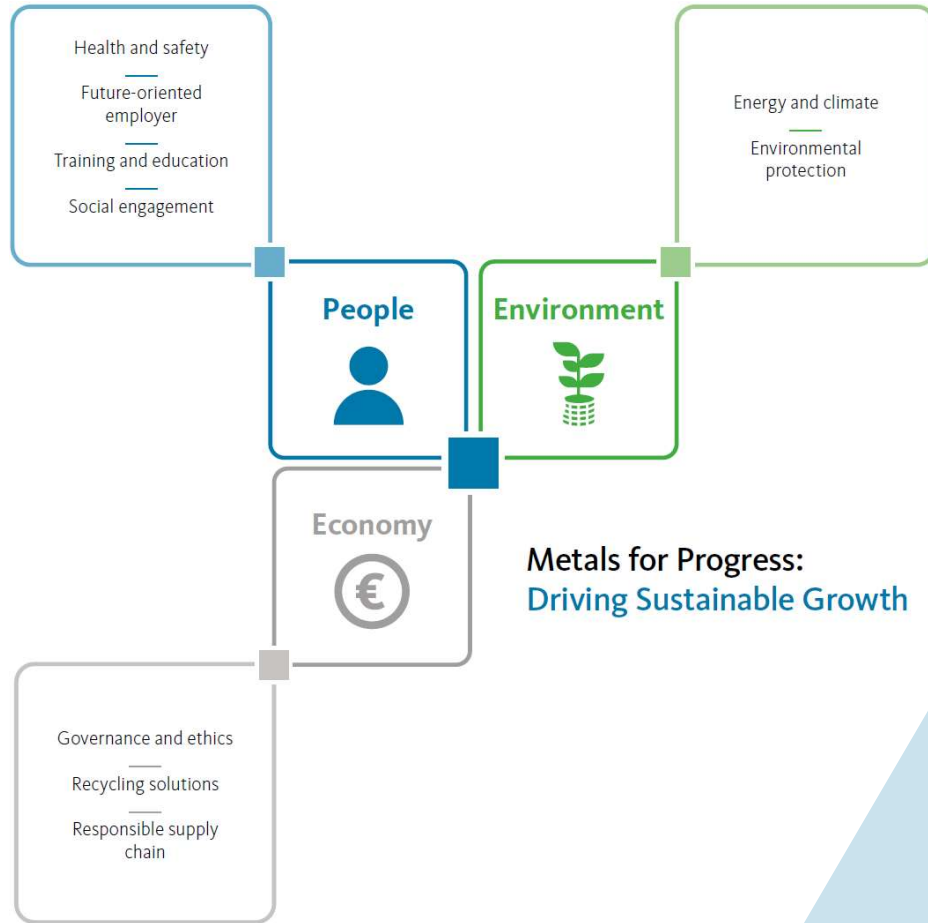

We continue to strengthen our position as the most efficient and sustainable multimetal producer worldwide

1

Sustainability is a fundamental part of Aurubis' strategy

2

We strive for **balance** between economy, environment, and people

3

9 action areas, targets and measures across E, S, and G

Renowned ratings show strong track record in sustainability



Aurubis' main sustainability ratings & initiatives



The Copper Mark certification demonstrates our leadership in sustainable production practices



The Copper Mark launched for copper producers in March 2020



Focus on steady improvement of the sector's production practices



Aurubis Olen certification expected shortly



Basis: UN SDGs & Risk Readiness Assessment



Joint Due Diligence Standard enables effective due diligence



Review of 32 sustainability criteria



Aurubis Bulgaria, Hamburg, and Lünen already certified for meeting The Copper Mark's requirements



The copper value chain can be sustainable – promoting and driving this industry initiative demonstrates our responsibility and growing momentum for a more sustainable product.



Our KPIs underline our sustainability ambitions and demonstrate momentum



Absolute Scope 1+2 CO₂ emissions
(in kt)

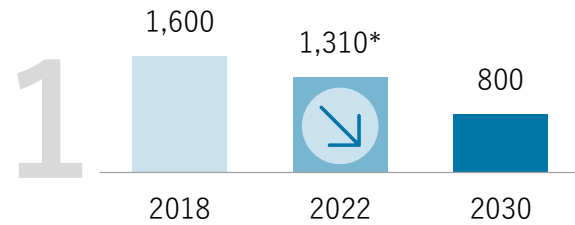

* Preliminary figures

Scope 3 CO₂ emissions
(in kt)¹

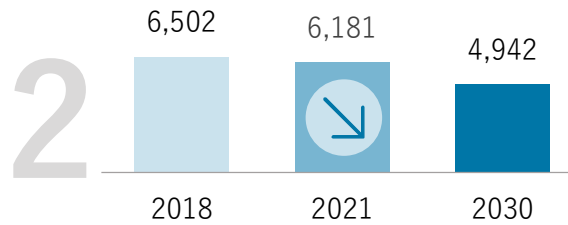

Air emissions (dust)
(in g per t of multimetal Cu equivalent)²

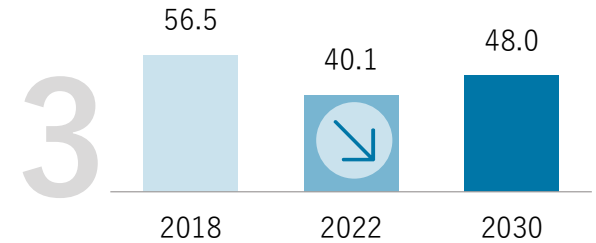

Metal emissions to water
(in g per t of multimetal Cu equivalent)²

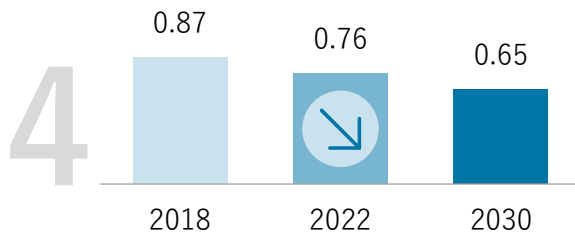

Supply chain integrity

For all identified High Risk Business Partners we implemented action plans. This has reduced our Business Partner risk.³

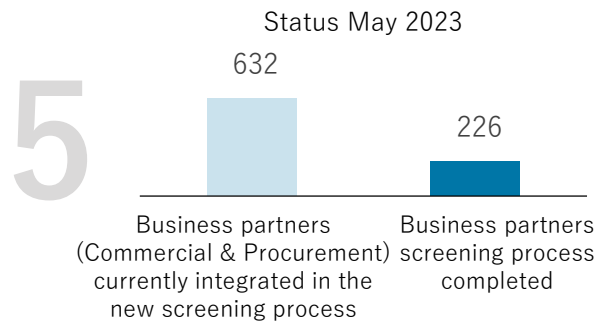

Recycling content (Cu)
Recycling share of Cu cathodes (in %)

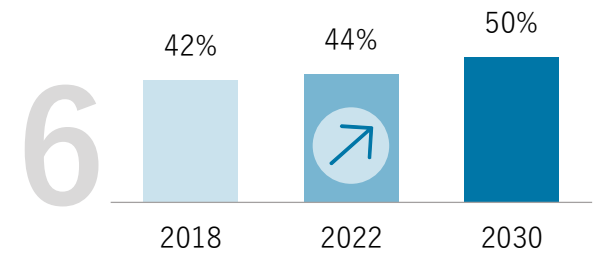

¹ Assumed steady copper cathode production until target year (physical intensity target)

² Multimetal Cu equivalent: total metal produced at Aurubis smelters (Cu, Zn, Ni, Pb, Sn, Au, Pd, Pt, Ag, Rh, Se, Te) x weight factors

³ Aurubis is introducing a revised and uniform Business Partner Screening system in FY 2022/23, in which we bundle the requirements of the various regulations, standards, and initiatives.

Leading the way with life cycle assessments – and substantially lower carbon footprints than industry averages



CO₂ footprint of Aurubis metals vs. global industry average

Copper cathodes

in kg CO₂ eq./t Cu

Global industry average

2013: 4,027

-5 %

2019: 3,833



Aurubis

2013: 2,300

-36 %

2021: 1,460



Remark: The environmental profiles have been verified by TÜV Nord Cert in accordance with DIN EN ISO 14040:2021 and DIN EN ISO 14044:2021.

Source: International Copper Association 2019, Aurubis LCA 2021

Tin

in kg CO₂ eq./t

2020: 6,632

Int'l Tin Association

2021: 1,570

Aurubis

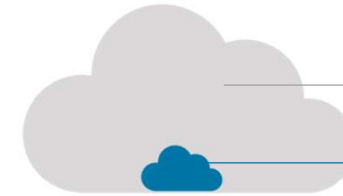

Silver

in kg CO₂ eq./kg

2021: 448

Ecoinvent

2021: 209



Gold

in kg CO₂ eq./kg

2019: 36,400

World Gold Council

2021: 16,200



» Aurubis continuously pursues better energy efficiency: lowering costs, improving CO₂ footprint

Achieving results: Using multiple technologies at our sites to decarbonize our production

Scope 1+2 CO₂ emissions

Absolute Scope 1+2 CO₂ emissions (in kt)

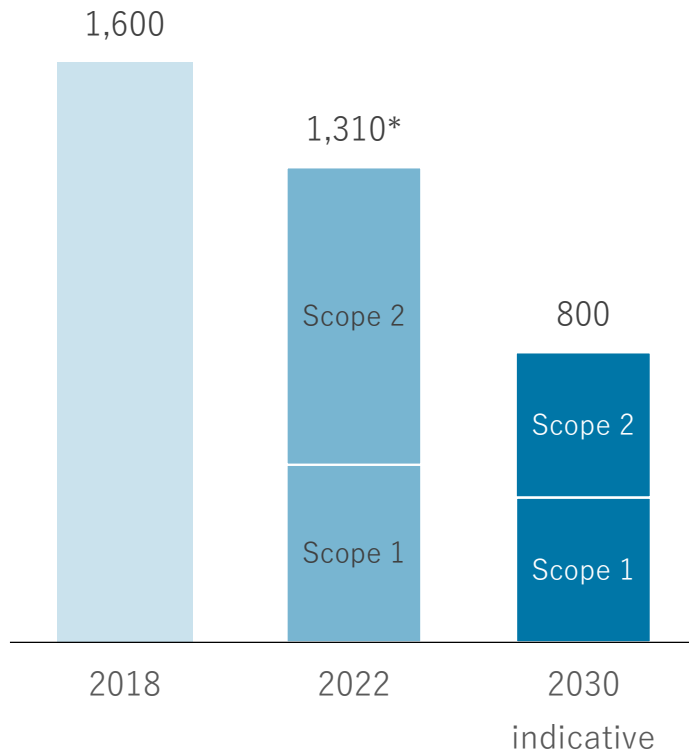

* Preliminary figures

Aurubis / Roadshow Paris July 5th 2023

Identified further potential for reducing our Scope 1+2 CO₂ emissions

Scope 2



Purchasing electricity from renewable sources, e.g., using new PPAs



Internal production of electricity from renewable sources



Energy efficiency measures

Scope 1



Use of alternative energy sources (i.e., hydrogen, ammonia)



Further electrification of production processes



Energy efficiency measures

Sustainability: Energy and decarbonization projects



PV Pirdop I-III



Sustainability: Aurubis on its way to carbon-neutral production



| | | |
|--|--|---|
| <p>Investment</p> <p>+~ € 12 million (for 2024 expansion)</p> | <p>Optimizing electricity consumption p.a.</p> <p>~ 13,500 MWh* (since PV 1)</p> <p>+~ 17,000 MWh (by Q2 2024)</p> |  <h2>Industry Leadership in Sustainability</h2> |
| <p>Start of production</p> <p>Q2 2024</p> | <p>CO₂ savings p.a.</p> <p>+ ~ 34,000 t</p> <p>compared to coal-fired power generation</p> | <p>Expansion of solar park until 2024 in Pirdop, Bulgaria, with a combined performance of 24 MWp.</p> <p>The solar park will reduce the smelter's external electricity consumption by approx. 30,000 MWh annually, and for the period of 15 years, the total renewable energy production will amount to approx. 450,000 MWh.</p> <p>Further expansions are planned with investments underway.</p> <p>Compared to coal-fired power generation, this will save up to 34,000 t of CO₂ emissions p.a. – or over 500,000 t over the operating period.</p> |

* Better performance than anticipated (11,000 MWh)

» **Further reduction of our already very small CO₂ footprint within the international sector and expansion of our leading position in environmental protection**

Win-win project reduces our carbon footprint and makes Aurubis a highly valuable source for sustainable district heat supply

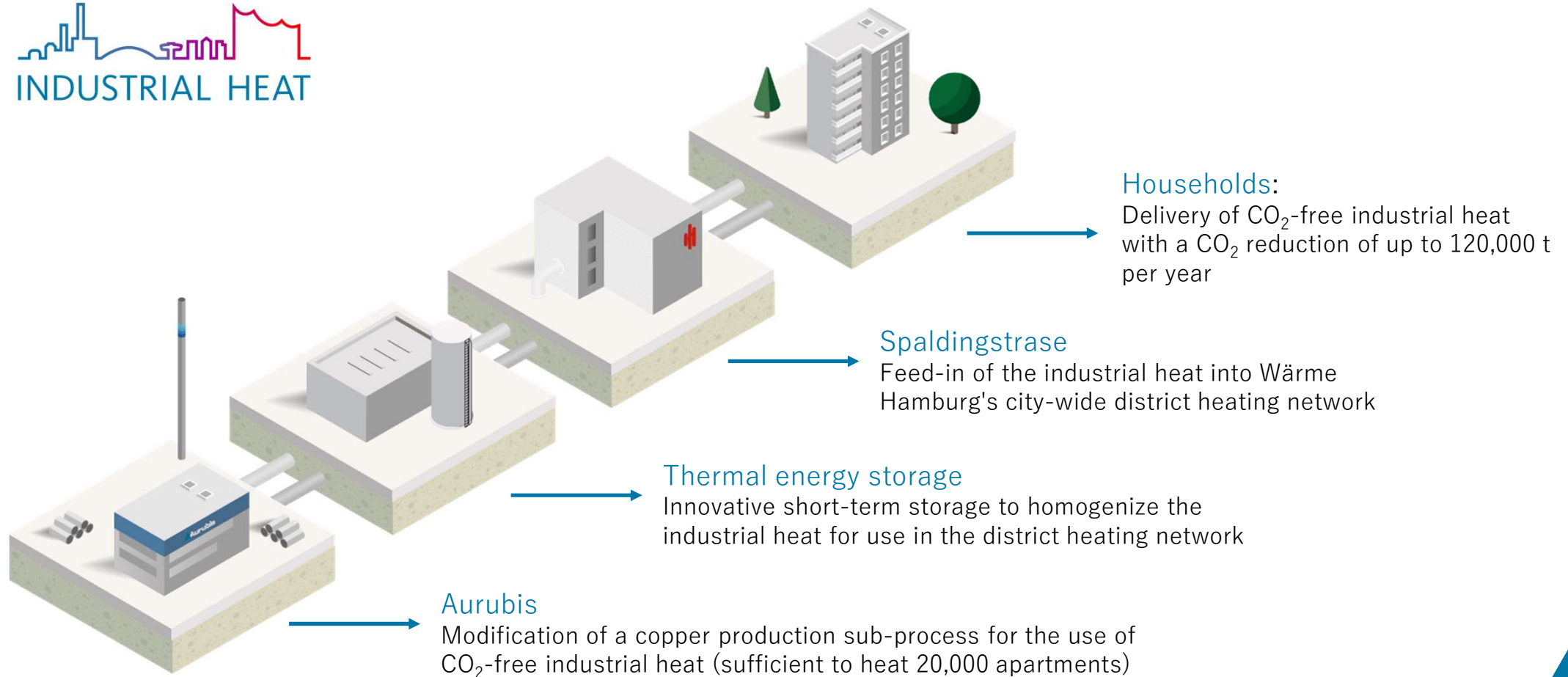

Monetizing its industrial heat, Aurubis strengthens its symbiotic partnership with the city of Hamburg



Project generates carbon savings potential of up to **20,000 t of CO₂ p.a. for Hamburg**; Aurubis' follow-up project with remaining industrial heating potential will lead to even higher **carbon reduction of 100,000 t p.a.**



Industry Leadership in Sustainability

Existing project supplies heat (as industrial by-product) to [Hamburg's HafenCity East](#) district, running successfully with [enercity](#) since 2018

Follow-up project helps the city of Hamburg to achieve its [climate goals](#) and supports Aurubis' [sustainability ambition](#) by further reducing our carbon footprint

Cost efficiency and project profitability achieved through [funding](#) from the German Federal Ministry for Economic Affairs and Energy and revenues from heat sales to [Wärme Hamburg GmbH](#)

» Our industrial heating delivers sustainable heat and will more than halve CO₂ emissions of the city of Hamburg by 2030.

Thank you for your participation.

For further questions, contact:
IR@aurubis.com

 **Aurubis**



Financial calendar

- Q3 2022/23 August 7, 2023
- Annual Report 2022/23 December 6, 2023

Your IR Contacts



Angela Seidler

VP Investor Relations,
Corporate Communications
& Sustainability

+49 40 7883-3178

a.seidler@aurubis.com



Elke Brinkmann

Head of Investor Relations

+49 40 7883-2379

e.brinkmann@aurubis.com



Ferdinand von Oertzen

Specialist Investor Relations

+49 40 7883-3179

f.vonoertzen@aurubis.com

Aurubis at a glance

Based in [Hamburg](#), Aurubis AG develops its leading market position with a [responsible approach](#) to the [environment](#), [people](#), and [resources](#)



The company's main expertise is in optimally [processing concentrates](#) and [recycling raw materials](#) with complex qualities

[Metallurgical know-how](#), [state-of-the-art plant facilities](#), and extraordinarily [high environmental standards](#) for the sector make Aurubis an attractive partner for raw material suppliers



The company, which was founded in 1866 as [Norddeutsche Affinerie AG](#), is listed in the [MDAX](#) and produces more than [1 million t of copper cathodes](#) and various copper products from them with around [7,100 employees](#) worldwide



The Group is [active in more than 20 countries](#) and has production sites concentrated in [Europe](#) and [North America](#)



Aurubis is one of the world's leading producers of cathodes, rod, and flat rolled copper products

Maintenance shutdowns in the next 3 years



EBT effect from maintenance shutdowns (in € million)

| | FY 2022/23 | | FY 2023/24 | | FY 2024/25 | |
|-----------------------------|----------------|-----|----------------|-----|----------------|-----|
| Smelter maintenance Hamburg | | | May/ June 2024 | ~36 | | |
| Smelter maintenance Pirdop | May/ June 2023 | ~20 | | | May/ July 2025 | ~35 |
| Anode furnace Lünen | Nov/ Dec 2022 | ~7 | Nov/ Dec 2023 | ~8 | Nov/ Dec 2024 | ~8 |
| KRS Lünen | May 2023 | ~9 | May 2024 | ~9 | May 2025 | ~9 |

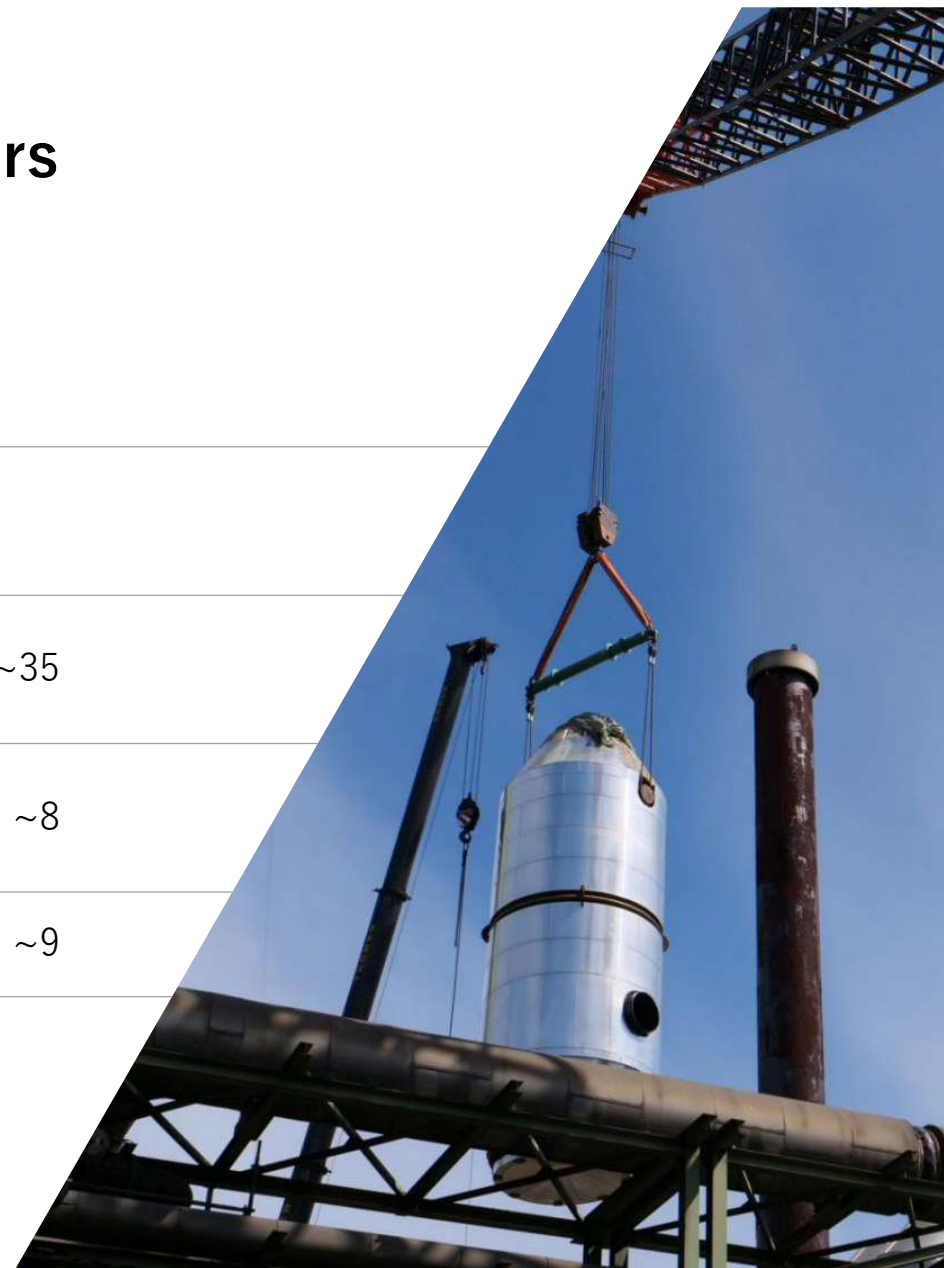

Primary copper production process

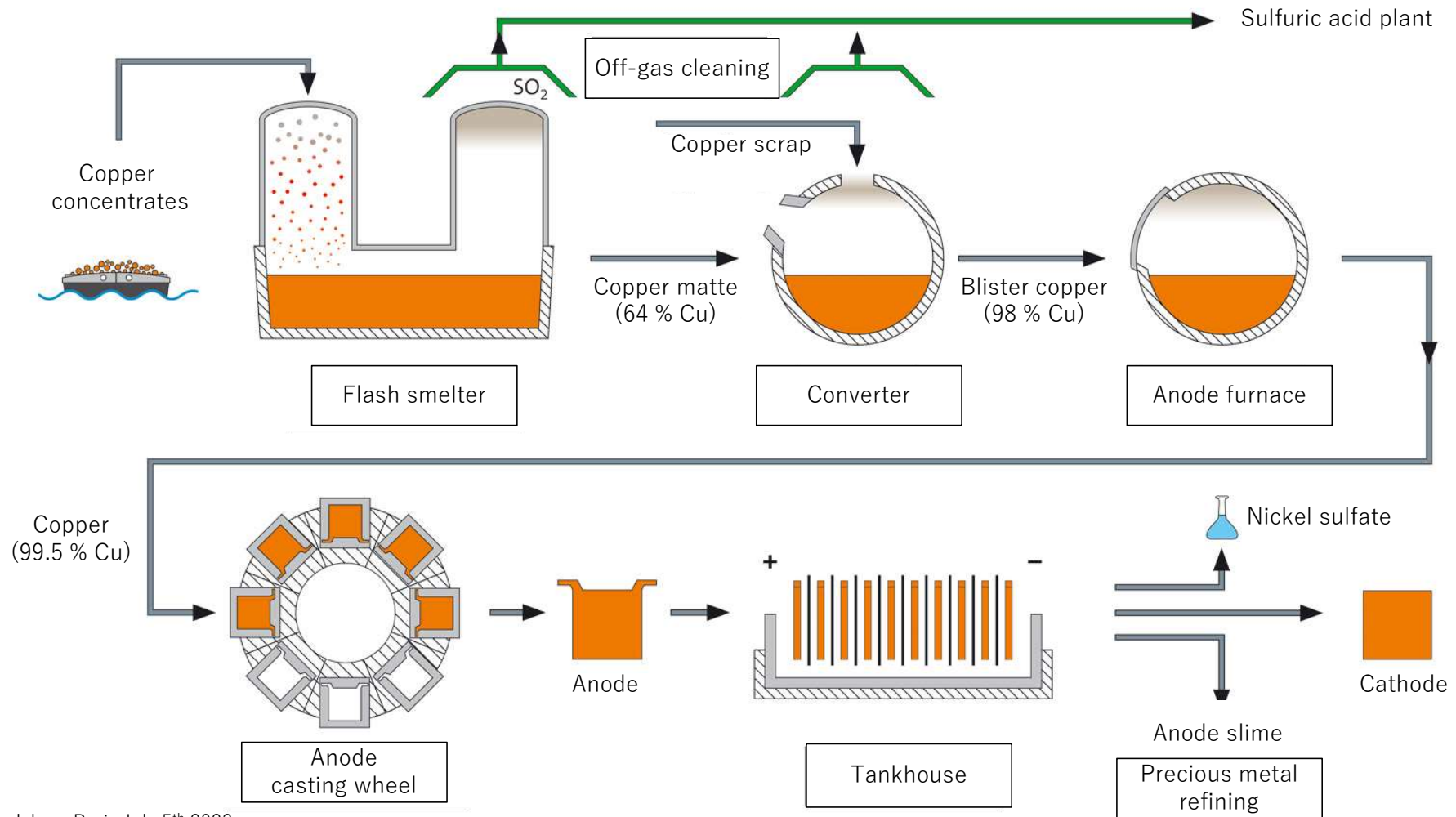

Disclaimer

Forward-looking statements

This document contains forward-looking statements that involve risks and uncertainties, including statements about Aurubis' plans, objectives, expectations, and intentions. Readers are cautioned that forward-looking statements include known and unknown risks and are subject to significant business, economic, and competitive uncertainties and contingencies, many of which are beyond the control of Aurubis. Should one or more of these risks, uncertainties, or contingencies materialize, or should any underlying assumptions prove incorrect, actual results could vary materially from those anticipated, expected, estimated, or projected.

Sustainalytics:

Copyright ©2020 Sustainalytics. All rights reserved. This [publication/ article/ section] contains information developed by Sustainalytics (www.sustainalytics.com). Such information and data are proprietary of Sustainalytics and/or its third party suppliers (Third Party Data) and are provided for informational purposes only. They do not constitute an endorsement of any product or project, nor an investment advice and are not warranted to be complete, timely, accurate or suitable for a particular purpose. Their use is subject to conditions available at <https://www.sustainalytics.com/legal-disclaimers>.

MSCI:

THE USE BY AURUBIS OF ANY MSCI ESG RESEARCH LLC OR ITS AFFILIATES ("MSCI") DATA, AND THE USE OF MSCI LOGOS, TRADEMARKS, SERVICE MARKS OR INDEX NAMES HEREIN, DO NOT CONSTITUTE A SPONSORSHIP, ENDORSEMENT, RECOMMENDATION, OR PROMOTION OF AURUBIS BY MSCI. MSCI SERVICES AND DATA ARE THE PROPERTY OF MSCI OR ITS INFORMATION PROVIDERS AND ARE PROVIDED 'AS-IS' AND WITHOUT WARRANTY. MSCI NAMES AND LOGOS ARE TRADEMARKS OR SERVICE MARKS OF MSCI.